

MSA CONTROL - (11) 3961-1171 - comercial@msacontrol.com.br

ø22, ø30 Command Switches Equipped with Synchro Safe Contact

# Emergency Stop Pushbutton Switches AR22VQR/VQL, VPR, AR30VPR/VPL

Full Specification of Emergency Stop Pushbutton Switches Equipped with Safety Function



**Enhanced safety**

- New safety function: Synchro safety contact

Just in case the Contact unit is removed from the operator, the switch is safe because the main NC contact opens (OFF).

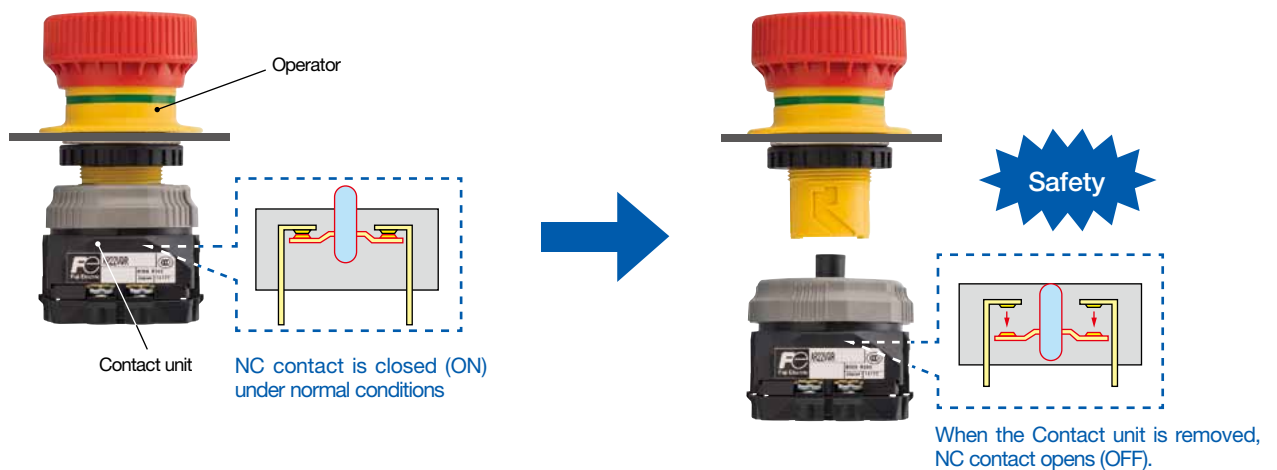

● Side indicator is adopted by default (except for AR30V)

The operating condition can be confirmed with the side indicator, and this helps prevent any accident being caused by a misunderstanding.

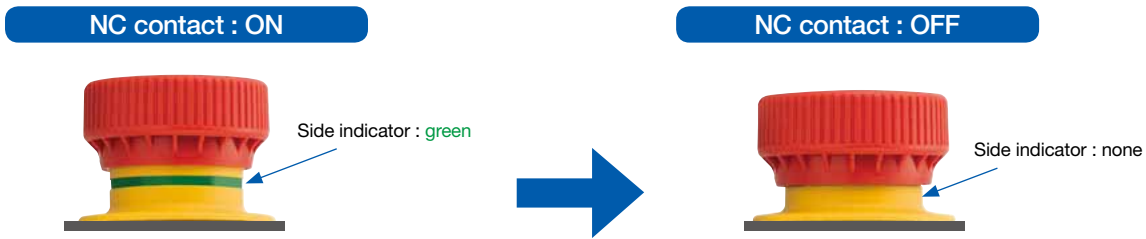

● Support for Padlock (except for AR22V)

To avoid a restart due to careless reset of a pushbutton switch in case of emergency stop, make use of Padlock or HASP.



The total mass should be 1500 g or less. For information on applicable Padlock and HASP, refer to the final page.

● Integrated frame (bezel) for the protrusion

Since the protrusion is integrated with the frame (bezel), there is no need to acquire it separately as an accessory.



● Enhanced visibility by adopting white arrow on all models.

Also, the flange (yellow) has become bigger, so it is easy to confirm background yellow without the nameplate. (except for AR30)

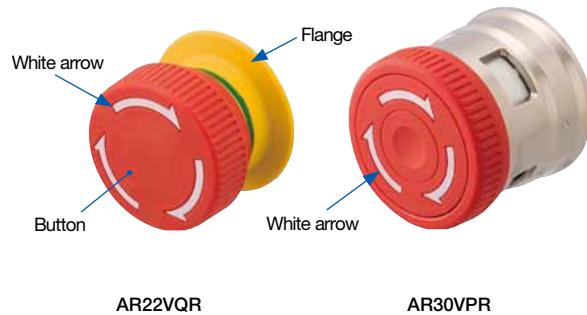

- Safety trigger-action mechanism that prevents the contacts from operating until the switch is locked, even if people or objects accidentally come into contact with the switch. (compliant with ISO13850/EN418)
- Direct opening mechanism for NC contacts to ensure that the contacts can be opened even in the unlikely event that they become fused. (compliant with EN60947-5-1/JIS C 8201-5-1, Appendix K)
- Support by default for the degree of protection of operator: IP65 and the degree of protection of terminal section: IP2X (compliant with EN60204-1/JIS B 9960-1).
- Certified with UL/CSA standard and TÜV EN standard, and acquired China Compulsory Certification (CCC). CE mark is attached.
- UL category code NISD (EMERGENCY STOP DEVICE) under application



**Enhanced operability**

**Enhanced release performance of contact unit**

One Touch mounting. The wire is not twisted at the time of attaching and detaching the unit.



Only the release cover is turned around, and the contact is not turned around.

**Reduce panel-mounting depth, connectable to up to six contacts.**

"2NO+4NC" contacts (an emergency stop) enables you to construct two kinds of mechanical safety circuits (2NC: redundancy).

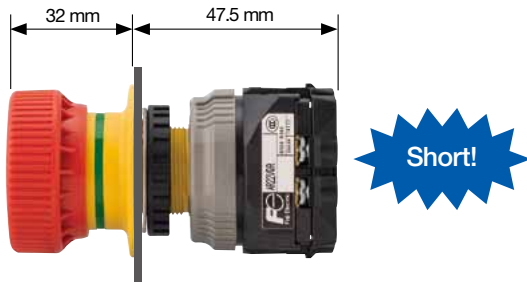

**Enhanced routing**

Since the layout of each contact is fixed regardless of the number of contacts, any miswiring can be prevented.

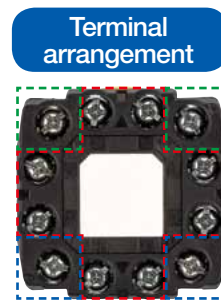

M3.5 is adopted for the terminal screw diameter. It is possible to unify it with other inner devices.

Contact arrangement	Non-illuminated type	Illuminated type	Illuminated type (interlocked with lamp circuit)
1NC to 4NC			
1NO 1NC to 4NC			
2NO 1NC to 4NC			

Red square means contact terminal "NC"  
Green square means a lamp terminal  
Blue square means contact terminal "NO"

- Pull-reset or turn-reset is available for the reset method (turn-reset only for AR30V type).
- The illumination can be interlocked with the lamp circuit.
- Adapter dedicated for ø30 mounting hole (except for AR30V)

**Terminal arrangement**

Emergency stop pushbutton switches	Emergency stop illuminated pushbutton switches	Emergency stop illuminated pushbutton switches (interlocked with a lamp circuit)

## Specifications (indoor use)

Item	Performance	
Rated insulation voltage $U_i$	250 V AC/DC	
Durability	Mechanical	250,000 operations
	Electrical	100,000 operations (AC-12, DC-13, DC-12)
Operating cycles per hour	900 operations/hour (On-load factor: 40%)	
Withstand voltage	Between live section and grounding: 2,000V AC, 1 minute	
	Between opposite polarity live sections: 2,000V AC, 1 minute	
Insulation resistance	Between live section and grounding: 100M $\Omega$ or more (500V DC megger)	
	Between opposite polarity live sections: 100M $\Omega$ or more (500V DC megger)	
Rated impulse withstand voltage $U_{imp}$	2.5 kV	
Conditional short-circuit current	1000 A	
Short-circuit protective device	gG10A (IEC60269 fuse)	
Pollution degree	3 (panel inside: 2)	
Vibration	Malfunction: maximum double amplitude: 0.7 mm (maximum: 50 m/s <sup>2</sup> ), frequency: 10 to 500 Hz	
	Durability: maximum double amplitude: 0.7 mm (maximum: 50 m/s <sup>2</sup> ), frequency: 10 to 500 Hz <sup>-1</sup>	
Shock	Malfunction: 150 m/s <sup>2</sup>	
	Durability: 1000 m/s <sup>2</sup> <sup>2</sup>	
Operational ambient temperature	Non illuminated type: -20 to +60°C, illuminated type: -20 to +50°C (no icing or no condensation)	
Storage temperature	-40 to +80°C (no icing or no condensation)	
Relative humidity	45 to 85%RH (-5 to +40°C) (no icing or no condensation)	
Degree of protection of operator (displaying) section	IP65 (dust-proof, water jet proof): IEC 60529	
Degree of protection of terminal section	IP2X (when wired)	
Connectable wire	Stranded wire: up to 1.25 mm <sup>2</sup> , 24 to 16 AWG-CU	
	Solid wire: up to $\phi$ 1.2 mm, 24 to 16 AWG-CU	

<sup>1</sup>: The feature is decided based on the test condition for EN60947-5-5 (1998).

<sup>2</sup>: Except when the switch is mounted upside down.

## Contact ratings

- TÜV (EN60947-5-1), CCC (GB14048.5), and JIS C 8201-5-1

Conventional free air thermal current (rated thermal current) $I_{th}$	Rated operational voltage $U_e$	Rated operational current $I_e$			
		AC		DC	
		AC-15 (Inductive load)	AC-12 (Resistive load)	DC-13 (Inductive load)	DC-12 (Resistive load)
5 A	24 V	–	–	1.0 A	2.0 A
	120 V	3.0 A	5.0 A	–	–
	125 V	–	–	0.22 A	0.4 A
	240 V	1.5 A	3.0 A	0.1 A	0.2 A

- UL/CSA standards

- AC ( $\cos\phi = 0.35$ )

Contact rating Code	Conventional free air thermal current (rated thermal current)	120 V		240 V	
		Making current	Breaking current	Making current	Breaking current
B300	5 A	30 A	3 A	15 A	1.5 A

- DC ( $T_{0.95} = 6P$ )

Contact rating Code	Conventional free air thermal current (rated thermal current)	Making current & breaking current	
		125 V	250 V
R300	1 A	0.22 A	0.11 A

## Contact reliability

FUJI has confirmed that the product can be used in 1mA circuit conditions at 5V AC or DC.

The operable range, however, may vary depending on the operational ambient conditions and type of load.



## Lamp rating and current consumption

Type of lamp	Luminous color	Operational lamp voltage	Current consumption
LED lamp	Red	24 V AC/DC	7.5 mA AC, 7.5 mA DC

Note: The LED lamp of these products cannot be replaced.

**Types**

- ø22 command switches
- Emergency stop pushbutton switches

Operator	Appearance	Contact arrangement <sup>1</sup>	Type	Button color
Push-lock, turn-reset Mushroom head (ø40)		1NC	AR22VQR-01R	Red [R]
		1NO+1NC	AR22VQR-11R	
		2NC	AR22VQR-02R	
		1NO+2NC	AR22VQR-12R	
		1NO+3NC	AR22VQR-13R	
		4NC	AR22VQR-04R	
Push-lock, turn-reset Giant Mushroom head (ø65)		1NC	AR22VPR-01R	Red [R]
		1NO+1NC	AR22VPR-11R	
		2NC	AR22VPR-02R	
		1NO+2NC	AR22VPR-12R	
		1NO+3NC	AR22VPR-13R	
		4NC	AR22VPR-04R	
		2NO+4NC	AR22VPR-24R	

<sup>1</sup>: Contacts other than those in the table above are also available. 3NC [03], 2NO+1NC [21], 1NO+4NC [14], 2NO+2NC [22], 2NO+3NC [23]

- Emergency stop illuminated pushbutton switches

Operator	Appearance	Operational lamp voltage/ lamp type	Contact arrangement <sup>2</sup>	Type	Button color
Push-lock, turn-reset Mushroom head (ø40)		24 V AC/DC LED lamp	1NC	AR22VQL-01E3R	Red [R]
			1NO+1NC	AR22VQL-11E3R	
			2NC	AR22VQL-02E3R	
			1NO+2NC	AR22VQL-12E3R	
			1NO+3NC	AR22VQL-13E3R	
			4NC	AR22VQL-04E3R	
		24 V AC/DC LED lamp Interlocked with lamp circuit	1NO+4NC	AR22VQL-14E3R	
			1NC	AR22VQL-01EAR	
			1NO+1NC	AR22VQL-11EAR	
			2NC	AR22VQL-02EAR	
			1NO+2NC	AR22VQL-12EAR	
			1NO+3NC	AR22VQL-13EAR	
			4NC	AR22VQL-04EAR	
			1NO+4NC	AR22VQL-14EAR	

<sup>2</sup>: Contacts other than those in the table above are also available. 3NC [03]

- ø30 command switches
- Emergency stop pushbutton switches

Operator	Appearance	Contact arrangement <sup>1</sup>	Type	Button color
Push-lock, turn-reset Mushroom head (ø44)		1NC	AR30VPR-01R	Red [R]
		1NO+1NC	AR30VPR-11R	
		2NC	AR30VPR-02R	
		1NO+2NC	AR30VPR-12R	
		1NO+3NC	AR30VPR-13R	
		4NC	AR30VPR-04R	
Support for Padlock		2NO+4NC	AR30VPR-24R	

<sup>1</sup>: Contacts other than those in the table above are also available. 3NC [03], 2NO+1NC [21], 1NO+4NC [14], 2NO+2NC [22], 2NO+3NC [23]

- Emergency stop illuminated pushbutton switches

Operator	Appearance	Operational lamp voltage/ lamp type	Contact arrangement <sup>2</sup>	Type	Button color
Push-lock, turn-reset Mushroom head (ø44)		24 V AC/DC LED lamp	1NC	AR30VPL-01E3R	Red [R]
			1NO+1NC	AR30VPL-11E3R	
			2NC	AR30VPL-02E3R	
			1NO+2NC	AR30VPL-12E3R	
			1NO+3NC	AR30VPL-13E3R	
			4NC	AR30VPL-04E3R	
		24 V AC/DC LED lamp Interlocked with lamp circuit	1NO+4NC	AR30VPL-14E3R	
			1NC	AR30VPL-01EAR	
			1NO+1NC	AR30VPL-11EAR	
			2NC	AR30VPL-02EAR	
			1NO+2NC	AR30VPL-12EAR	
			1NO+3NC	AR30VPL-13EAR	
			4NC	AR30VPL-04EAR	
			1NO+4NC	AR30VPL-14EAR	

<sup>2</sup>: Contacts other than those in the table above are also available. 3NC [03]

■ Dimensions, mm

● AR22VQR

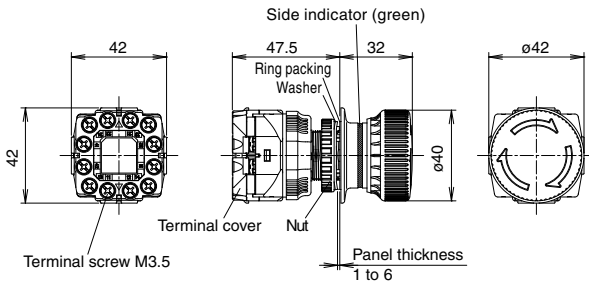

● AR22VPR

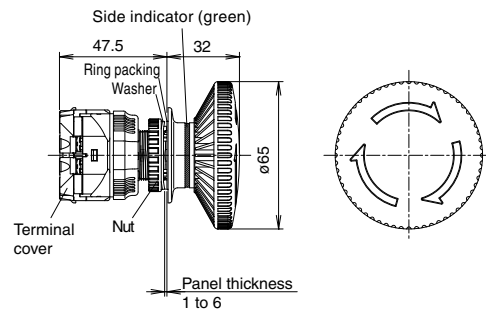



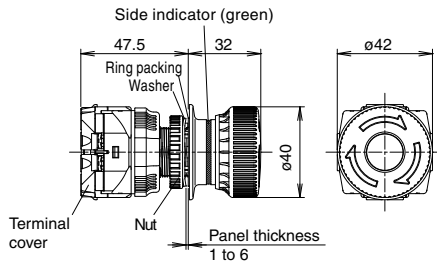

● AR22VQL

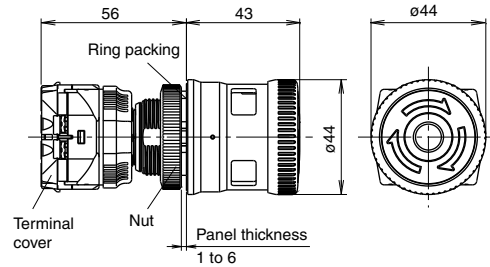

● AR30VPR / VPL

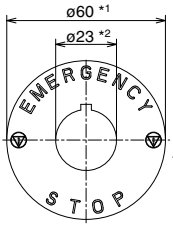

■ Accessories

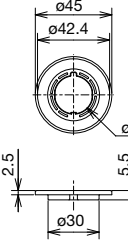
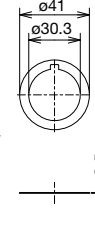
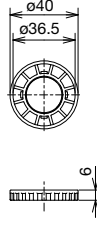
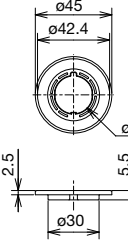
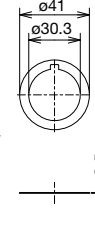
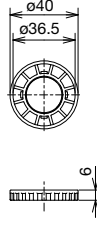
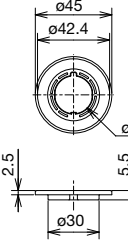
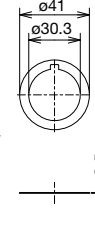
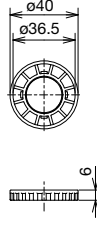
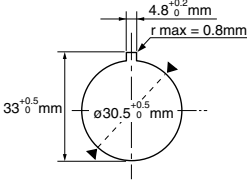
Description	Type	Dimensions								
	<table border="1"> <tr> <th>Type</th> <th>Used with</th> </tr> <tr> <td>AR9A701</td> <td>AR22VQR, VQL, VPR</td> </tr> <tr> <td>AHX536</td> <td>AR30VPR, VPL</td> </tr> </table>	Type	Used with	AR9A701	AR22VQR, VQL, VPR	AHX536	AR30VPR, VPL	AR9A701: ø28 mm × 60 mm AHX536 : ø32 mm × 76 mm		
	Type	Used with								
AR9A701	AR22VQR, VQL, VPR									
AHX536	AR30VPR, VPL									
Application: This allows you to tighten the tightening ring when mounting the command switch on a panel.										
	<table border="1"> <tr> <th>Type</th> <th>Used with</th> </tr> <tr> <td>AR9P722-(1)(2)</td> <td>AR22VQR, VQL</td> </tr> <tr> <td>AR9P723-(1)(2)</td> <td>AR22VPR</td> </tr> <tr> <td>AR9P724-(1)(2)</td> <td>AR30VPR, VPL</td> </tr> </table>	Type	Used with	AR9P722-(1)(2)	AR22VQR, VQL	AR9P723-(1)(2)	AR22VPR	AR9P724-(1)(2)	AR30VPR, VPL	 <p>Thickness: 0.35</p> <p>[Unit: mm]</p>
	Type	Used with								
	AR9P722-(1)(2)	AR22VQR, VQL								
	AR9P723-(1)(2)	AR22VPR								
AR9P724-(1)(2)	AR30VPR, VPL									
Note 1: The values of code (1) and (2) above represent the Legend below to be printed on the Legend plate										
<table border="1"> <tr> <th>Type</th> <th>Code (1), (2)</th> <th>Letter height</th> </tr> <tr> <td>Blank</td> <td>00</td> <td></td> </tr> <tr> <td>EMERGENCY STOP</td> <td>5A</td> <td>5 mm</td> </tr> </table>		Type	Code (1), (2)	Letter height	Blank	00		EMERGENCY STOP	5A	5 mm
Type	Code (1), (2)	Letter height								
Blank	00									
EMERGENCY STOP	5A	5 mm								
Note 2: These Legend plate are pasted on the product. Note 3: The color of the Legend plate is yellow and the Legend color is black.										
AR22VQ□, VPR ø30 mounting adapter 	<table border="1"> <tr> <th>Type</th> </tr> <tr> <td>AR9Y958</td> </tr> </table>	Type	AR9Y958	<table border="1"> <tr> <th>ø30 mounting adapter</th> <th>ø30 packing</th> <th>ø30 tightening nut</th> </tr> <tr> <td></td> <td></td> <td></td> </tr> </table>	ø30 mounting adapter	ø30 packing	ø30 tightening nut			
	Type									
AR9Y958										
ø30 mounting adapter	ø30 packing	ø30 tightening nut								
										
Application: • This adapter allows you to mount the switch on a panel of ø30.5mm cutout in combination with the operator of AR22VQ□ and VPR (made of plastics, with ring packing and tightening nut). • The applicable panel thickness is 1 to 4.5 mm.										
Applicable panel cutout size 										



### Control box dedicated for emergency stop pushbutton switch

#### Features

- Control box for mounting the emergency stop pushbutton switch AR22VQR/VQL, VPR.
- It is easy to mount or add this box to the desired places away from the operating panel.
- The excellent dust-proof and water jet proof performances of IP65 (when using applicable connector) make this box ideal when mounting it on food machines and machines used in a dusty environment.
- Double-insulation structure without the need for an earth wire. (compliant with IEC536 class II)
- The knockout holes open at the top, bottom, and back.
- The emergency stop Legend plate (AR9P722) can be mounted.

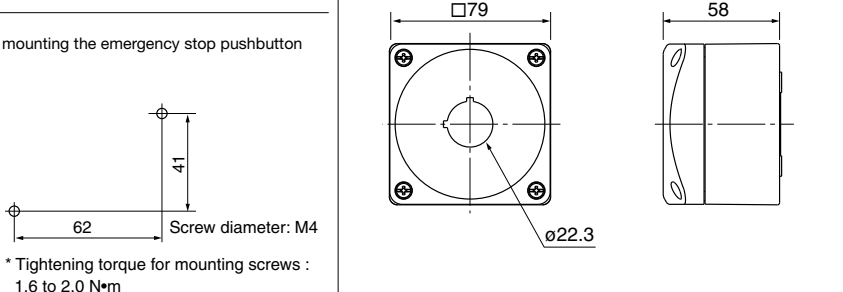

Description	Type	Outline dimensions
	<b>Type</b> AR9Y920 <b>Application:</b> <ul style="list-style-type: none"> <li>Plastic control box for mounting the emergency stop pushbutton switch separately.</li> <li>Mounting pitch</li> </ul>	[Unit: mm] 
	* Tightening torque for mounting screws : 1.6 to 2.0 N•m	

#### Applicable connector

- Knockout holes at the top and bottom: M20, Pg13.5, or G1/2  
Recommended connector: MG20 series, MS13.5, MS-M20 x 1.5, manufactured by Hagitec inc.
- Knockout holes at the back: M14 or G1/4  
Recommended connector: SCL-B6A manufactured by Hagitec inc.

### Panel cutout [mm]

#### • AR22

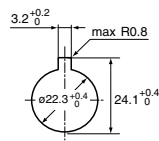

#### • AR30

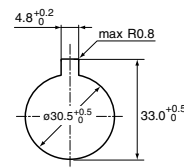

### Applicable panel thickness

The applicable panel thickness is 1 to 6mm. However, the thickness of the applicable panel to which ø30 switches having their mounting adapters are mounted should be 1 to 4.5mm.

If a legend plate is used, the panel should be made thinner by subtracting the thickness of that component.

Note: If a legend plate or such kind of one is used for between the switch and the fitting surface of the panel, the thickness of the legend panel should be 1.6mm or less. If the thickness exceeds the value of 1.6mm, it may prevent the fixing function of the switch.

### Mounting the switch

#### Removing the operator from the contact unit

- Pull down the release cover of the contact unit,
- turn it counter clock wise in 15 degrees,
- at the position pull the contact unit, after that, the contact unit can be removed from the operator.

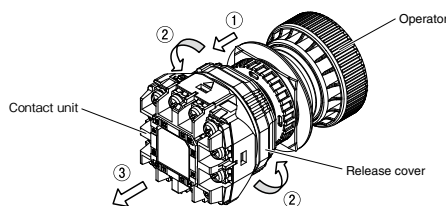

#### Caution at the removing process of the contact unit from the operator

- When the contact unit is removed from the operator, at the process, "NO" contact of the unit is turned into "ON" position.
- At the process when the contact unit is removed from the operator, don't give excessive force to the unit. It may cause the switch to break or to go into maloperation.
- During the removing work of the contact unit from the operator, not depending on the operation position of the operator, temporarily the NC contact becomes at conductive state (At the time, the NO contact is at open state).

#### Mounting the operator on the panel

Remove the tightening nut and washer from the packaged state of the operator, checking the packing whether it is placed properly on to the fitting surface of the front side of the panel, insert the operator keeping whose ▼ mark at the top position into the installation hole of the panel.

The operator penetrates the panel through the installation hole to the rear side of the panel. It is fixed at the rear side of the panel with the tightening nut turned by the tightening wrench.

Note 1 : The proper tightening torque is 1.0 to 1.5N•m for AR22, and 1.5 to 2.5N•m for AR30.

Note 2 : The tightening nut has two faces, convex and concave. Face the concave side of it to the panel when it tightens up the operator at the rear side of the panel. If it is used in the opposite face, the operator will not be fixed properly there.

Note 3 : Check the tightening nut regularly whether it tightens the operator properly. If it seems that tightening is not sufficient, do not forget to tighten the screw increasingly.

Note 4 : Do not use pliers or other improper tools to tighten the nut, and do not tighten it excessively, or the nut may be damaged or the switch may malfunction.

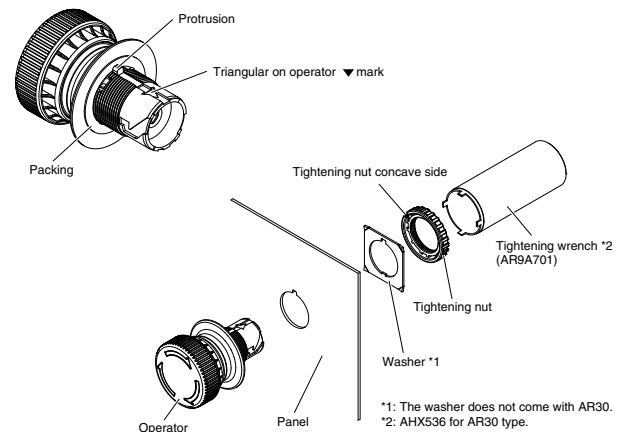

\*1: The washer does not come with AR30.  
\*2: AHX536 for AR30 type.

**Mounting the contact unit**

Meet the mark ▲ on the contact unit to the same mark ▼ on the operator, insert the contact unit completely into the operator until it makes a click sound. (The click sound tells that the contact unit is completely connected to the operator.)

Please consider it when you do it.

After the contact unit is set, could you check the sequence and confirm the unit whether it operates well?

• Caution when the contact unit is set in

- (1) The "position" of the release cover of the contact unit which is being connected to the operator is different from the "position" of it of the contact unit which is removed from the operator. However, it is normal.
- (2) When the contact unit is connected to the operator, it should be connected in the specified correct way. When two units are connected, meet the apex of the triangle mark on the contact unit to the apex of the triangle mark on the operator. Connecting the units without meeting each apex of their triangle marks may cause the switch to break. If there is a switch recognized broken is remained there, it should not be used for any purpose.
- (3) During the mounting work of the contact unit from the operator, not depending on the operation position of the operator, temporarily the NC contact becomes at conductive state (At the time, the NO contact is at open state).

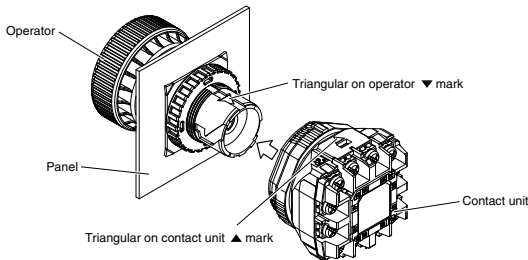

**Others**

**Operation**

- Do not hit or flip the button, or the button may be damaged. Be sure to operate the button by hand. Operate the switch manually. Don't use any tools such as a hammer or other tool to hit the switch for operation. It may break the switch.
- To unlock the switch, turn the button approximately 45° clockwise (in the direction of the arrow) or pull out the button. Do not operate or handle the button with excessive force.

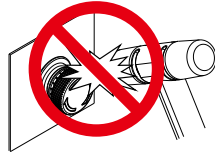

**Effect of receiving shock for the switch**

- Effect of receiving shock for the switch ranges in the installation directions of it therefore, the installation direction should be considered for the switch to avoid effect of receiving excessive shock. On the right bottom of this instruction paper, below is a figure which shows a switch installed on to the panel. When a certain value of shock is given to the switch in the direction of the arrow mark which shows the direction of gravity, the switch receives the gravitational mass effect of the button. Therefore, at the situation, the switch is easy to go into maloperation compared with other installation directions that don't give the gravitational mass effect of the button to the switch.

- Could you avoid any excess shock given to the emergency stop switch? If an excess shock is given to the switch, contact bounce may occur in the switch, it may cause a trouble in the circuit.

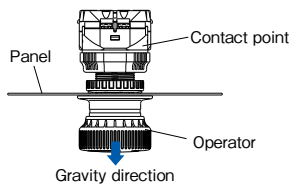

**Contact unit**

- The contact unit is not provided with dust proof, water proof or oil-tight construction. Therefore, don't allow liquid or cutting chips to pass through inside or the unprotected contact unit.
- Don't give any excessive physical load or shock to the contact unit. It may break the switch or make it in trouble to lose its ON and OFF function.
- If the release cover of the individual contact unit is turned or twisted, the contacts are switched. Please consider it when you handle it.

**Storage and Usage Locations**

- Be sure to use and store the product within the rated ambient temperature and humidity ranges.
- Although the product resists ordinary cutting oils and coolant oils, do not use the unit in places where special oils may be sprayed onto the product. If you are in such case, could you call us at the phone described below? We will give you a solution.
- If dusts or filings accumulate in the gap between the button and the frame, the switch may fail to operate normally.
- This switch are for indoor use. Don't use the switch for outdoor use and make sure that the product is not exposed to direct sunlight.
- Do not use the product in the places that are subject to the adverse effects of ozone or corrosive gases.

**Applicable Padlock and HASP [unit: mm]**

**Padlock**

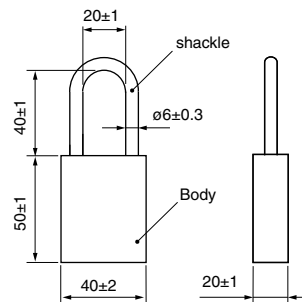

Manufacturer	Type
Master Lock	6835KARFRED

**HASP**

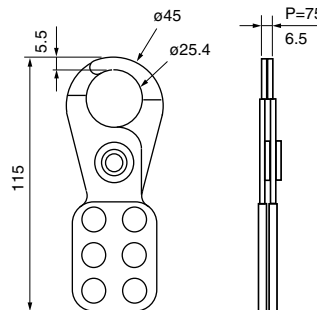

Manufacturer	Type
Master Lock	420, 421

\* This figure shows the dimensions of a type-420 HASP.

- The total mass of the Padlock and HASP should be 1500 g or less.

**Others**

Before mounting this product, wiring cables, operating this product, or maintaining and inspecting this product, make sure you read this "Instruction Manual" and use this product properly.