

Manual Motor Starters Magnetic Contactors

MSA CONTROL - (11) 3961-1171 - comercial@msacontrol.com.br

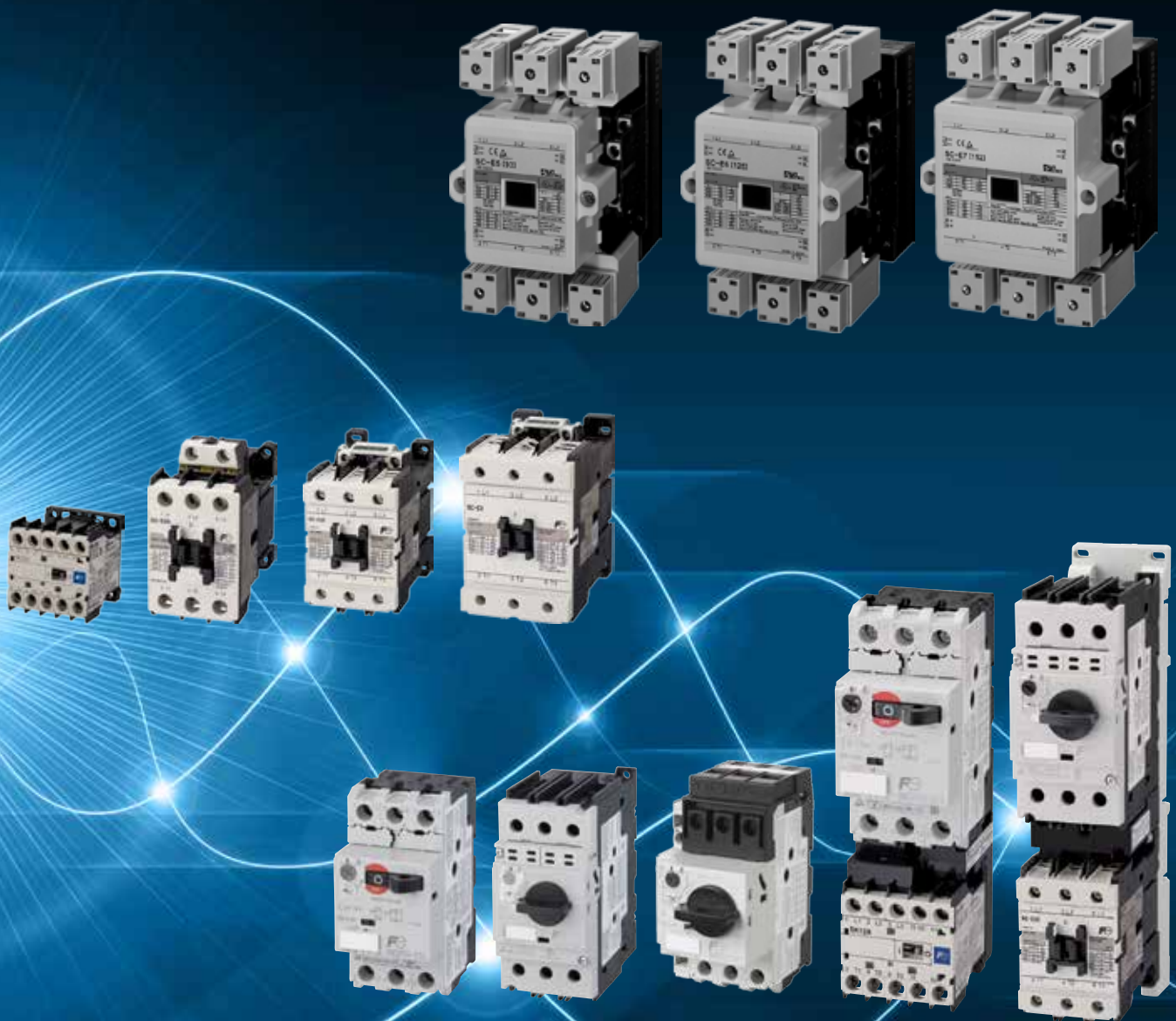

Advanced Motor Protection and Control – Fuji Electric DUO series

Fuji Electric's new motor control system for the international market.

MSA CONTROL - (11) 3961-1171 - comercial@msacontrol.com.br

The DUO series adds a new family of compact, high-performance combination starters to manual motor starters BM3 series, magnetic contactors SK and SC-E series, and thermal overload relays TK12 and TK-E series to form a complete line-up of motor control products.

Responding to today's market needs, Fuji Electric DUO series was designed to provide various distinctive features.

ULTIMATE COST SAVING SOLUTION

- The number of components like Circuit Breakers can be reduced. (See page 4 to 7 for detail.)
- Combination starters combined with manual motor starters and contactors, provides 52% reduction for mounting space and 90% reduction for wiring work to make a control panel.

RESPONSE TO THE INTERNATIONAL MARKET

- Short-circuit protective coordination between protective devices and the equipment to be protected.
- Conformance to UL including Type E, Type F, CSA, IEC and other international standards.

SAFETY AND ECOLOGICAL CONSIDERATION

- Application of international standards in safety features such as terminals with finger protection.
- Use of recycled materials to help conserve the environment and save resources.

Fuji Electric meets emerging needs with a new form of motor protection.

DUO SERIES

Manual motor starters (MMS)

BM3 series



Manual Motor Starters that provide optimal protection by integrating the functions of a molded case circuit breaker and thermal overload relay into a highly compact unit.

Rated current: 0.16 to 32A, 10 to 63A
Short circuit current rating : 22, 50kA 480VAC
Width: 45mm, 55mm

Combination starters

Provide the ability to configure combination starters for compact, reliable motor protection by combining a manual motor starter and a magnetic contactor.



Contactors and thermal overload relays

SK series



Compact magnetic contactors and small capacity motor control for 3 to 5HP, 480VAC.

Rated capacity: AC-3 3 to 5HP, 480VAC
Width: 45mm

SC-E series

TK-E series



Magnetic contactors and thermal overload relays featuring terminals with finger protection for 5 to 100HP.

Rated capacity: AC-3 5 to 100HP
Width: 43,54,67mm (5 to 50HP)
88,100,115mm (60 to 100HP)

Manual Motor Starters BM3 series

MSA CONTROL - (11) 3961-1171 - comercial@msacontrol.com.br

Conforming to international standards and combining compactness with high breaking performance, this versatile series features leading-edge motor protection.

Molded case circuit breaker and thermal overload relay functions integrated into a highly compact unit.

Circuit breaker functions

- Short-circuit protection
- Overcurrent protection
- Line protection



Thermal overload relay functions

- Overload protection
- Phase-loss protection
- Rated current adjustment
- Ambient temperature compensation



Manual motor starter advantages



Compactness

Mounting space: MCCB + Thermal overload relay: 100%
MMS: 43% (57% reduction)

Reduction in wiring work

MCCB + Contactor + Thermal overload relay: 100%
MMS + Contactor: 50% (50% reduction)

Standards

- IEC 60947-1, 60947-2, 60947-4-1, UL 508, CSA C22.2 No.14

Approved

- cUL (File No. E163944, E211710), TÜV (R205062B)

Ecological design

- Recyclable thermoplastic resin used in plastic parts
- Indication of materials used
- Cadmium-free contacts

Magnetic Contactors SK and SC-E series

A full line-up consisting of the mini-contactor SK series for 3 to 5HP, 480VAC use and the SC-E series for 5 to 100HP 480VAC use.

- Finger protection standard
- Lug terminal

SK series



SK06, 09, 12

SC-E series



SC-E02 to E05



SC-E1 to E2S

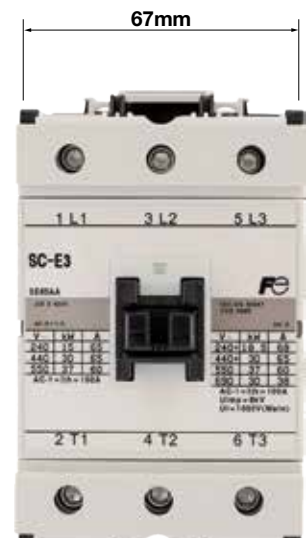

SC-E3, E4

Combination of Manual Motor Starters and Magnetic Contactors

MSA CONTROL - (11) 3961-1171 - comercial@msacontrol.com.br

A line-up that aims to set a new world standard for compactness, high performance, and utility in combination starters.

Space-saving, reliable motor protection achieved by combining a manual motor starter and magnetic contactor.

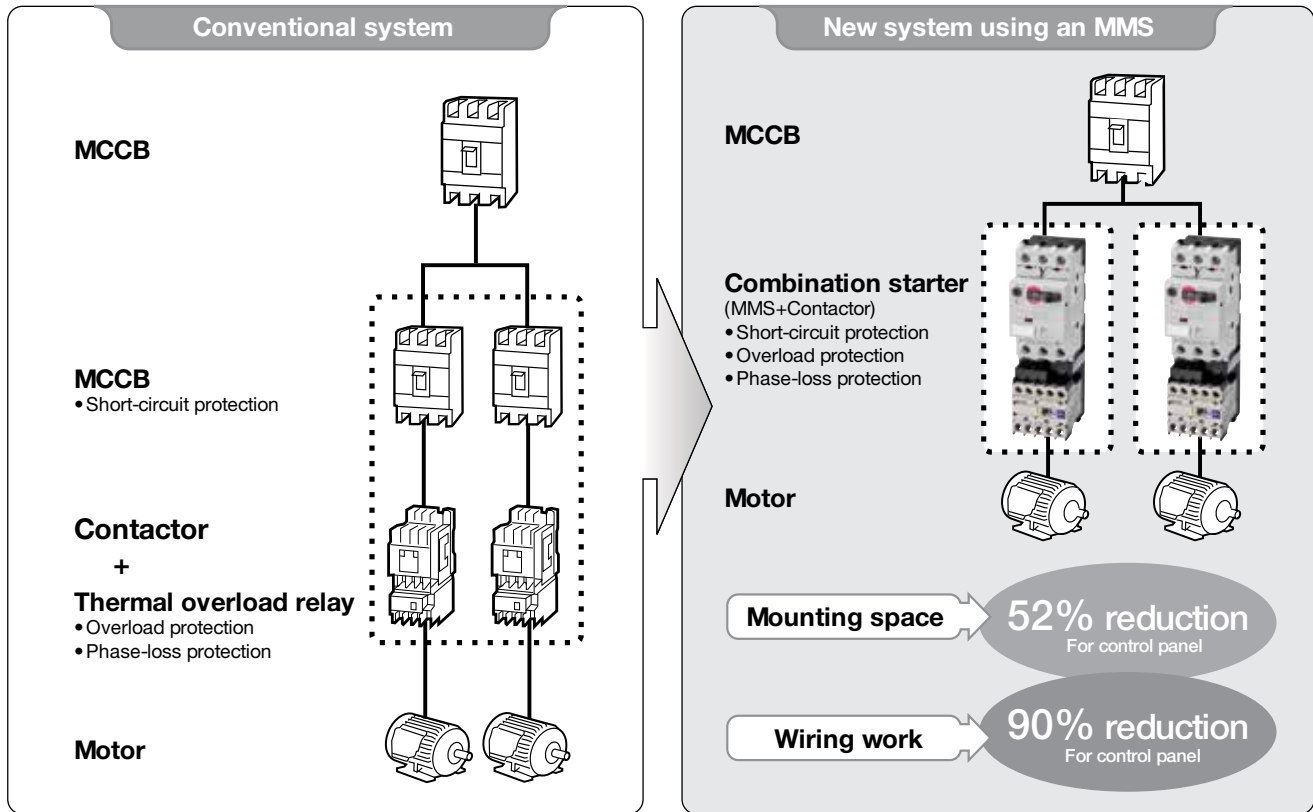

Combination starters can be easily configured with a manual motor starter, magnetic contactor and other parts.

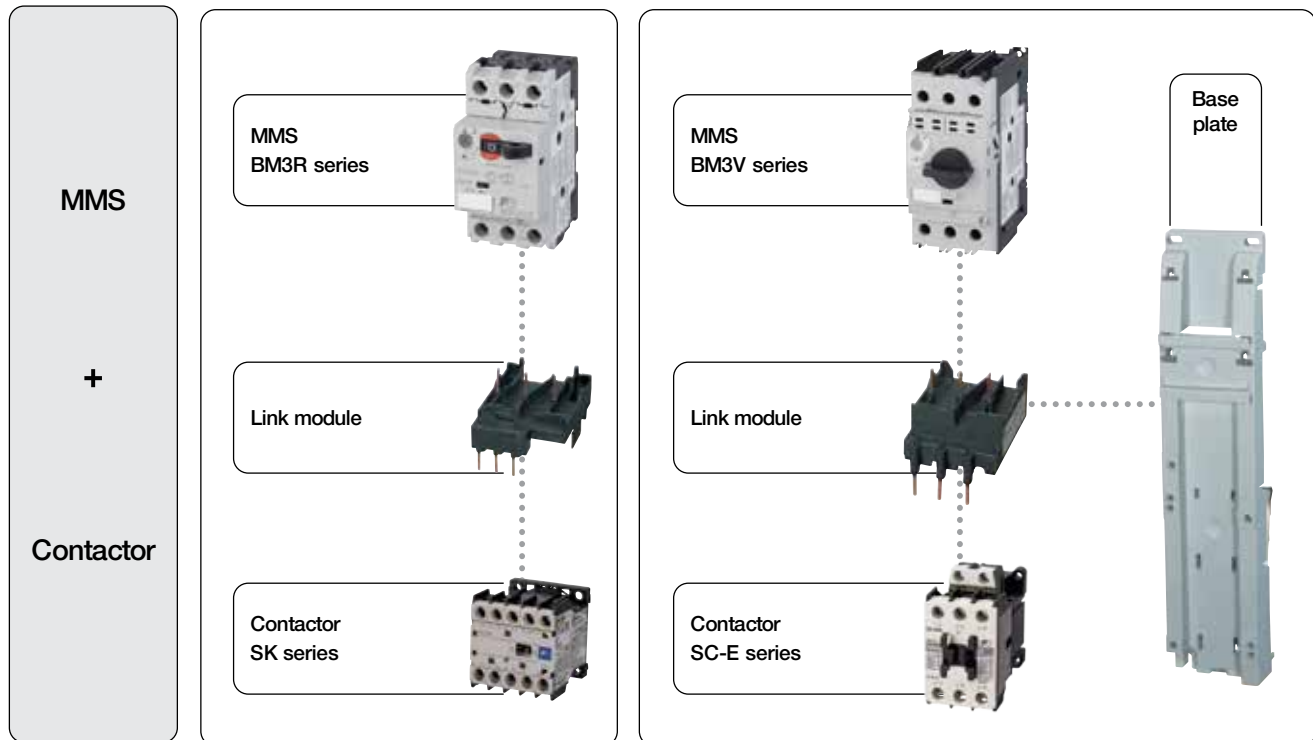

Ultimate Cost Saving Solution with DUO series

MSA CONTROL - (11) 3961-1171 - comercial@msacontrol.com.br

Fuji Electric Manual Motor Starter (MMS) intends to apply for manual motor starting application.

As UL listed manual motor controller per UL508, they provide overload protection but are required to be installed with short circuit protection devices (Fuses or Circuit Breakers) on the upstream.

However, according to National Electrical Code (NEC), you can save the cost of short circuit protection devices and can make a smaller panel using DUO series.

The following are case studies for the cost saving use of Fuji Electric's DUO series.

Case study 1 : Group Motor Installation

Per NEC430-52 and -53, the combination with a specific rated Fuse or Circuit Breaker allows several motors in a circuit composition.

Fuji Electric MMS are cUL listed per group installation regulations of NEC.

Two or more motors can be connected to one branch circuit when the MMS is used with a specific current rated branch circuit protection device (see remarks below).

The advantages of Group Installation are as follows.

- **The number of components (i.e. Circuit Breakers) can be reduced**
- **The wire size can be reduced by 1/3 - 1/10 under certain conditions**
- **The area inside the control panel can be minimized**

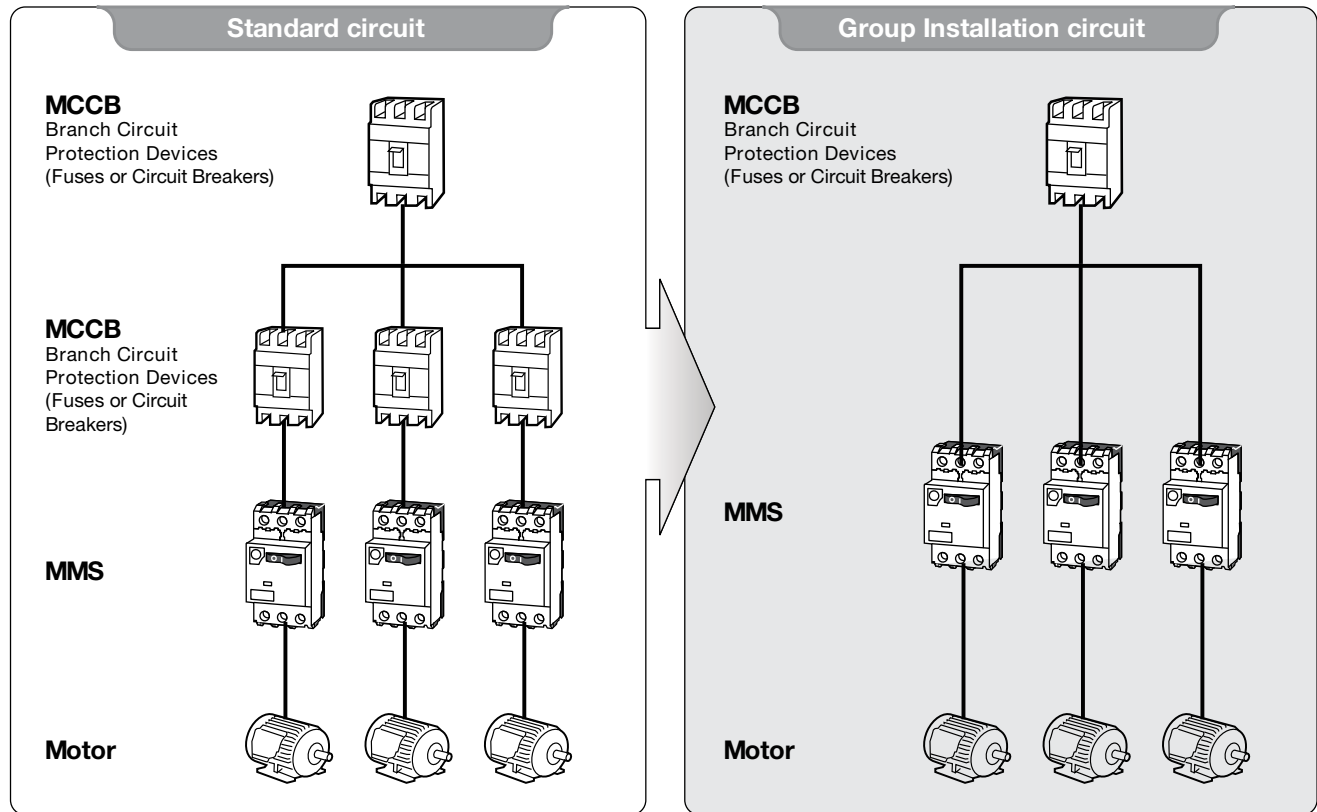

Remarks :

Per NEC regulations, to connect several motors on one branch circuit protection device, note the following conditions (A) or (B) or (C) and condition (D) listed NEC article 430.53 must be complied.

- (A) : Not over 1 horsepower
- (B) : If smallest rated motor protected
- (C) : Other group installation
- (D) : Single motor taps.

For complete details, please refer to NEC book.

Case study 2 : Self-Protected Combination Motor Controller / TYPE E and TYPE F

Fuji Electric MMS are cUL listed as a Self-Protected Combination Controller such as Type E and Type F. To apply MMS as Self-Protected Combination Controller, MMS must be attached to short circuit alarm contact block (**BZ0TKUAB**). 32A frame type, BM3R series must also be attached to the line side terminal cover (**BZ0TCRE**) because the Self-Protected Combination Controller has the clearance and creepage distance requirements as UL489 regulation. (63A frame type, BM3V series complies with their regulation without terminal cover.)

- (1) Combination motor controller, **Type E**, when only MMS is used.
(Manual Self-Protected Combination Motor Controller according to UL508)
- (2) Combination motor controller, **Type F**, when MMS is used with Fuji Electric SC-E, SK contactor.
(Manual Self-Protected Combination Motor Controller + Magnetic contactor according to UL508)

The advantage of a Self-Protected Combination Motor Controller is that it can replace a **UL489 Circuit Breaker**. **This means that in a motor branch circuit, the UL489 Circuit Breaker upstream can be eliminated.** MMS has a trip function like a Circuit Breaker for the purpose of protection against short-circuit. Therefore, the number of components can be reduced and will result in saving more space than the ordinary Group Installation.

* The self-protected combination motor controller can be used as branch circuit protection in Motor Circuit only. They cannot be applied to any other loads such as resistance load.

Example of Type E application

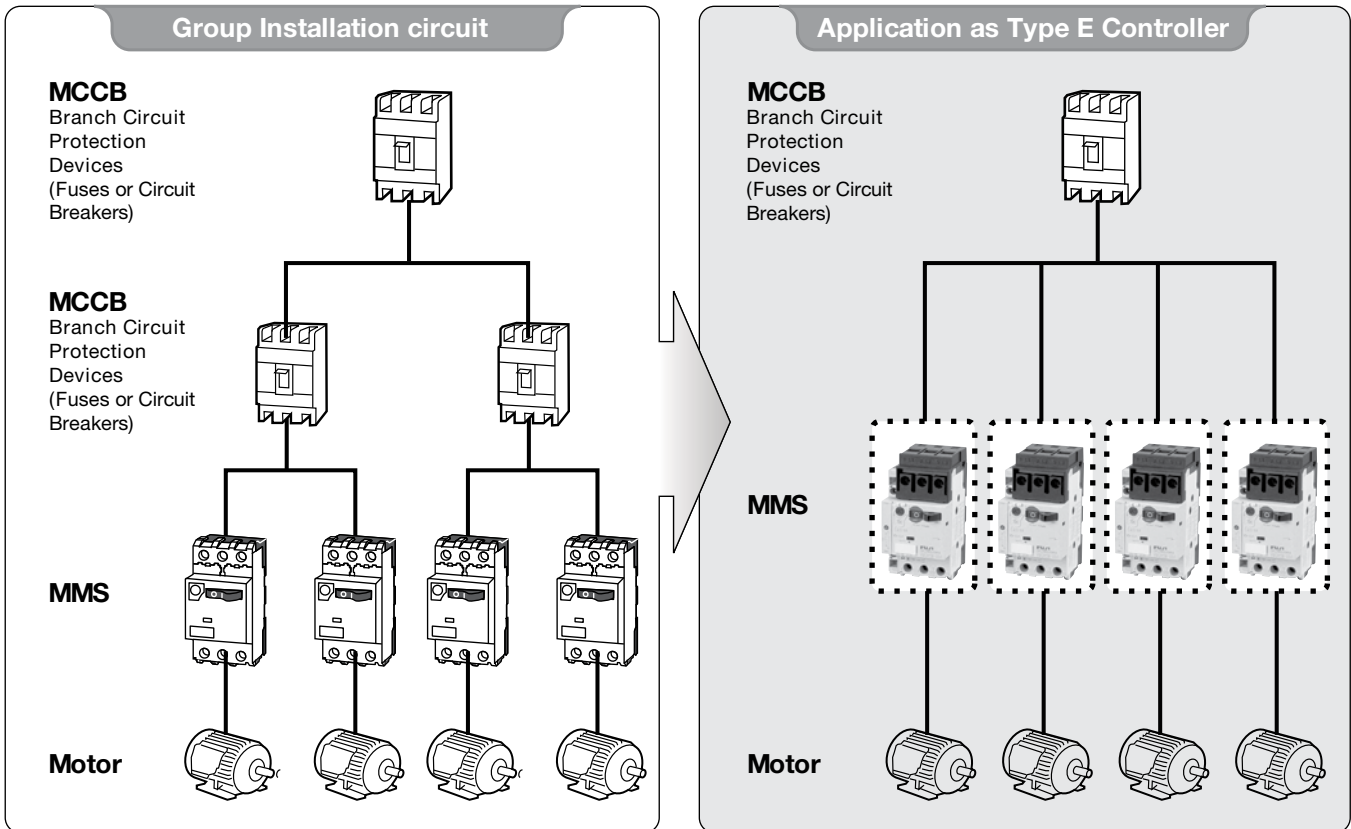

Requirements for Type E construction
- Terminal cover (BZ0TCRE) except for BM3V series.
- Short-circuit alarm contact block (BZ0TKUAB) for all MMS.

Example of Type F application

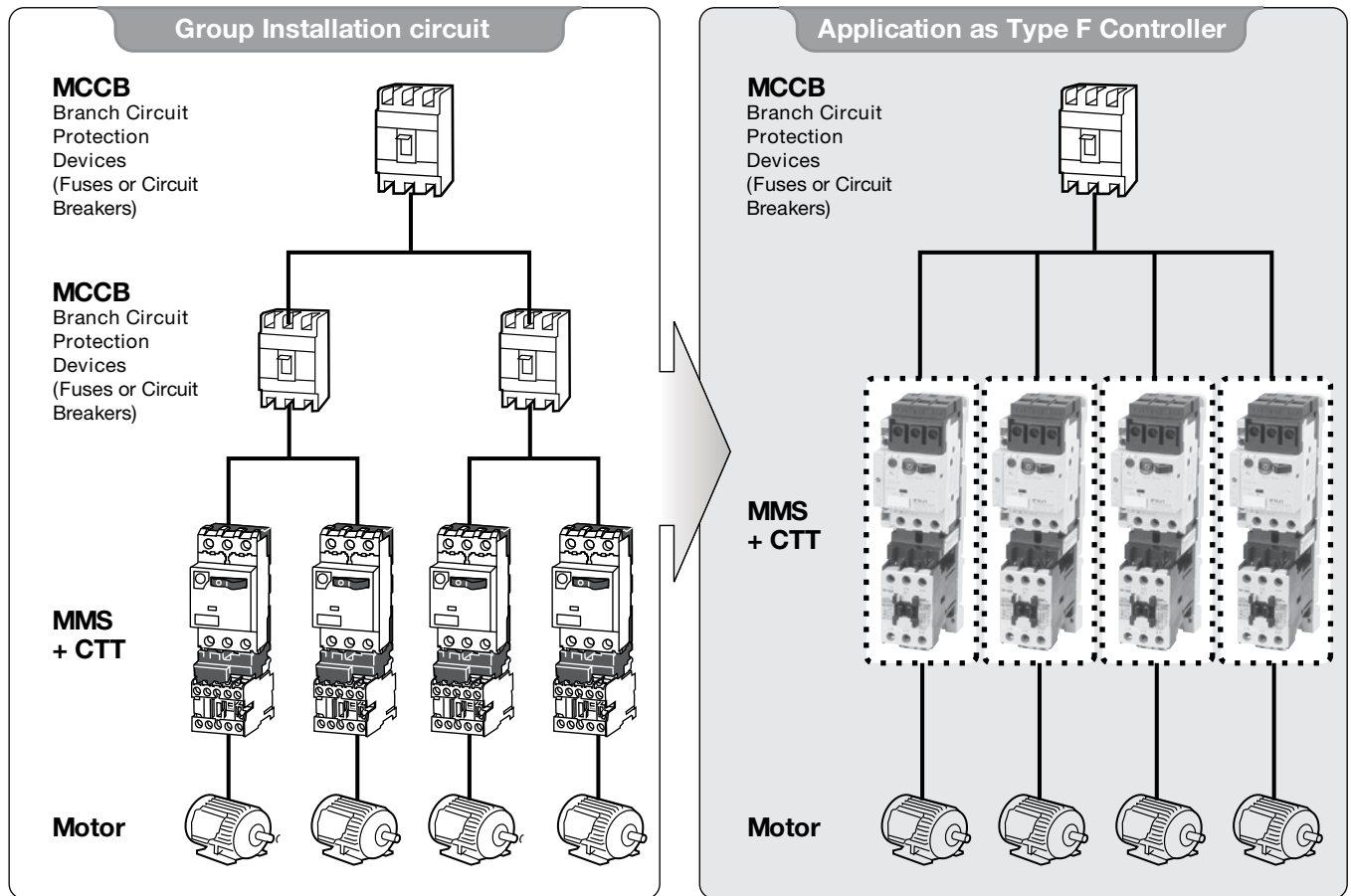

Requirements for Type F construction

- Must be used with contactor for motor control function.
- Terminal cover (BZ0TCRE) except for BM3V series.
- Short-circuit alarm contact block (BZ0TKUAB) for all MMS.

Case study 3 : Motor Disconnecting Means

Per NEC 430.102, a disconnecting means must be applied to each controller.

Fuji Electric MMS are also cUL listed as "Suitable as **Motor disconnect**" and can be applied as a Motor disconnect.

The advantage of using MMS for disconnect means :

- An extra component will not be needed because the MMS has a dual function, which will lead to smaller space requirement and less components.

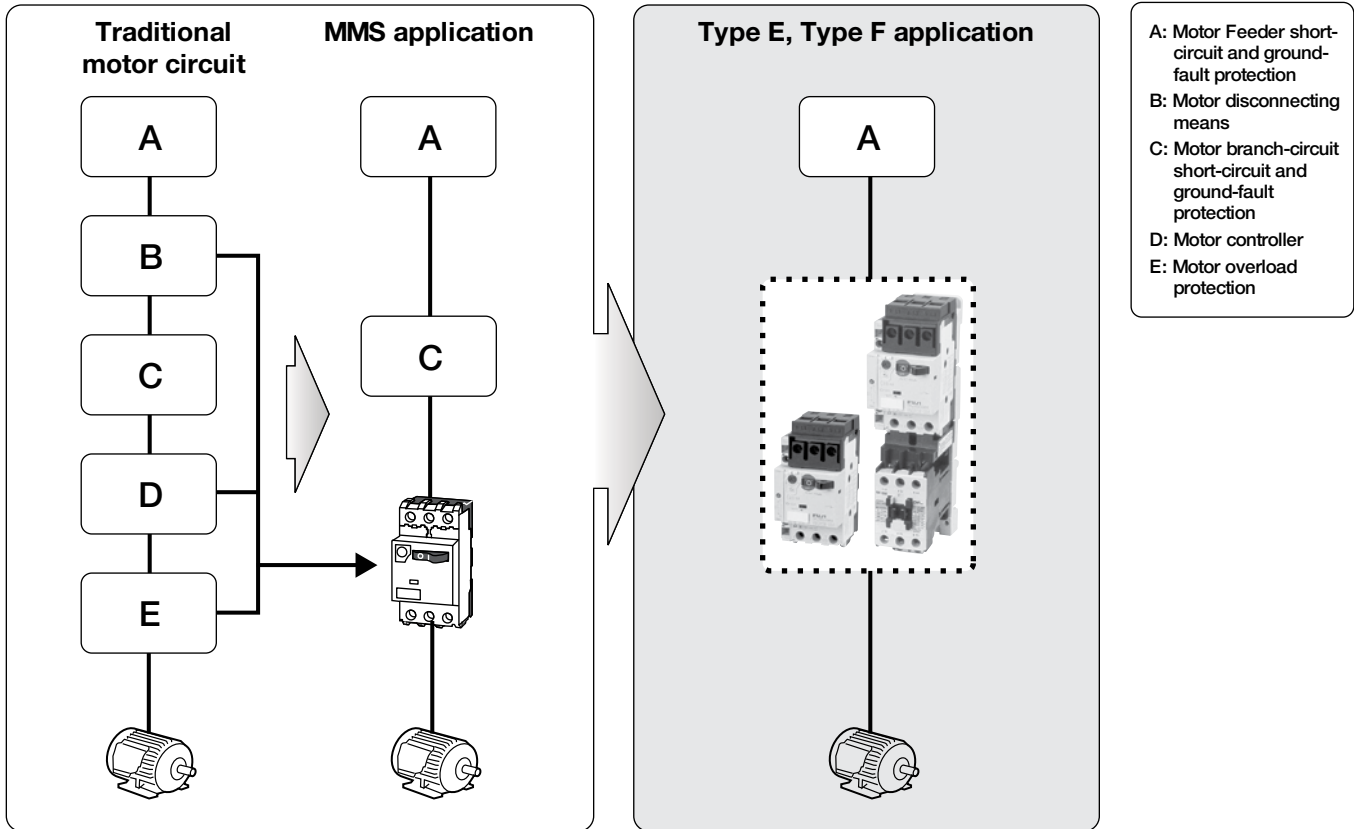

CONTENTS

MSA CONTROL - (11) 3961-1171 - comercial@msacontrol.com.br

	Page
Manual Motor Starters	
Quick reference guide	9
Type E ratings	13
Ordering information and Characteristics	14
Optional accessories	15
Dimensions	21
Instructions	25
Busbar systems	26
Enclosures	29
Contactors SC-E and SK series	
General information	31
Quick reference guide	32
Contactors SC-E series	
Ordering information and Characteristics	35
Optional accessories	37
Dimensions	39
Instructions	45
Thermal overload relays TK-E series	
Quick reference guide and Ordering information	46
Characteristics	47
Optional accessories	48
Dimensions	49
Instructions	51
Contactors SK series	
Ordering information and Characteristics	52
Optional accessories	59
Dimensions	65
Thermal overload relays TK12 series	
Quick reference guide and Ordering information	66
Characteristics	67
Optional accessories	68
Dimensions	69
SK series and TK12 series	
Notes on use	70
Combination Starters	
Quick reference guide	74
Optional accessories	78
Dimensions	81
Appendix	
Appendix 1 : Construction of combination motor controllers	86
Appendix 2 : Short circuit coordination comparison	86
Terms and conditions of sale	89

Manual Motor Starters

Quick Reference Guide

MSA CONTROL - (11) 3961-1171 - comercial@msacontrol.com.br

32A Frame Types and Ratings

Adjustable thermal-magnetic trip type		Standard breaking capacity BM3RSB-□								KK01-317
Number of poles		3								
Handle type		Rocker								
Rated current I _e (A)		0.16 to 32								
Rated operational voltage U _e (V)		200 to 690								
Rated frequency (Hz)		50/60								
Rated insulation voltage U _i (V)		690								
Rated impulse withstand voltage U _{imp} (kV)		6								
Utilization IEC 60947-2 Circuit breaker category		Cat. A								
IEC 60947-4-1 Motor starter		AC-3								
Trip class IEC 60947-4-1		10								
Instantaneous trip characteristic		13 × I _e max.								
Power loss (total of 3-pole)		7W: I _n =0.16 to 25A 8.5W: I _n =32A								
Mechanical durability (operations)		100,000: I _n =0.16 to 25A 70,000: I _n =32A								
Electrical durability (operations)		100,000: I _n =0.16 to 25A 70,000: I _n =32A								
Max. operations per hour (motor start-up)		25								
Phase-loss protection		Provided								
Trip indicator		Provided								
Test trip function		Provided								
Adjustable current range		UL/CSA 3phase HP rating (HP) *2				Instantaneous trip current (A)	UL/CSA Short circuit current rating (kA) *3			Maximum listed branch circuit protection *3 Fuse or MCCB (A)
Code *1	I _e : Min.–Max. (A)	200-208VAC	220-240VAC	440-480VAC	550-600VAC		240VAC	480VAC	600VAC	
P16	0.1–0.16	In accordance with Motor full load current				2.1	100	50	10	500
P25	0.16–0.25					3.3	100	50	10	500
P40	0.25–0.4					5.2	100	50	10	500
P63	0.4–0.63					8.2	100	50	10	500
001	0.63–1					1/2	13	100	50	10
1P6	1–1.6		3/4	3/4	20.8	100	50	10	500	
2P5	1.6–2.5	1/2	1/2	1	1-1/2	32.5	100	50	10	500
004	2.5–4	3/4	3/4	2	3	52	100	50	10	500
6P3	4–6.3	1	1-1/2	3	5	81.9	100	50	10	500
010	6.3–10	2	3	5	7-1/2	130	100	22	10	500
013	9–13	3	3	7-1/2	10	169	100	22	10	500
016	11–16	3	5	10	10	208	100	22	10	500
020	14–20	5	5	10	15	260	50	22	10	500
025	19–25	7-1/2	7-1/2	15	20	325	50	22	10	500
032	24–32	10	10	20	30	416	50	22	10	500
Dimensions (mm) W x H x D		45 x 90 x 66								
Mass (g)		350								
Optional accessory	Auxiliary contact block	<input type="radio"/>								
	Alarm contact block	<input type="radio"/>								
	Auxiliary and alarm contact block	<input type="radio"/>								
	Short-circuit alarm contact block	<input type="radio"/>								
	Shunt trip device	<input type="radio"/>								
	Undervoltage trip device	<input type="radio"/>								
	External operating handle	–								
Standard		IEC 60947-1, 60947-2, 60947-4-1, UL 508, CSA C22.2 No.14								

Notes: *1 Replace the □ mark in the part number by current range codes.

*2 The BM3RSB is cUL listed as HP rated motor controllers.

*3 The BM3RSB is cUL listed for group Installation as per NEC430-53(C).

Available

– Not available

MSA CONTROL - (11) 3961-1171 - comercial@msacontrol.com.br

■ 32A Frame Types and Ratings

Adjustable thermal-magnetic trip type	High breaking capacity BM3RHB-□				AF01-42					
Number of poles	3									
Handle type	Rotary									
Rated current I_e (A)	0.16 to 32									
Rated operational voltage U_e (V)	200 to 690									
Rated frequency (Hz)	50/60									
Rated insulation voltage U_i (V)	690									
Rated impulse withstand voltage U_{imp} (kV)	6									
Utilization category IEC 60947-2 Circuit breaker	Cat. A									
Utilization category IEC 60947-4-1 Motor starter	AC-3									
Trip class IEC 60947-4-1	10									
Instantaneous trip characteristic	$13 \times I_e \text{ max.}$									
Power loss (total of 3-pole)	7W: $I_n=0.16$ to 25A 8.5W: $I_n=32A$									
Mechanical durability (operations)	100,000: $I_n=0.16$ to 25A 70,000: $I_n=32A$									
Electrical durability (operations)	100,000: $I_n=0.16$ to 25A 70,000: $I_n=32A$									
Max. operations per hour (motor start-up)	25									
Phase-loss protection	Provided									
Trip indicator	Provided									
Test trip function	Provided									
Adjustable current range	UL/CSA 3phase HP rating (HP) *2				Instantaneous trip current (A)	UL/CSA Short circuit current rating (kA) *3	Maximum listed branch circuit protection *3			
Code *1	I_e : Min.–Max. (A)	200-208VAC	220-240VAC	440-480VAC	550-600VAC	240VAC	480VAC	600VAC	Fuse or MCCB (A)	
P16	0.1–0.16	In accordance with Motor full load current				2.1	100	50	10	500
P25	0.16–0.25					3.3	100	50	10	500
P40	0.25–0.4					5.2	100	50	10	500
P63	0.4–0.63					8.2	100	50	10	500
001	0.63–1			1/2	13	100	50	10	500	
1P6	1–1.6			3/4	3/4	20.8	100	50	10	500
2P5	1.6–2.5	1/2	1/2	1	1-1/2	32.5	100	50	10	500
004	2.5–4	3/4	3/4	2	3	52	100	50	10	500
6P3	4–6.3	1	1-1/2	3	5	81.9	100	50	10	500
010	6.3–10	2	3	5	7-1/2	130	100	50	10	500
013	9–13	3	3	7-1/2	10	169	100	50	10	500
016	11–16	3	5	10	10	208	100	50	10	500
020	14–20	5	5	10	15	260	100	50	10	500
025	19–25	7-1/2	7-1/2	15	20	325	100	50	10	500
032	24–32	10	10	20	30	416	100	50	10	500
Dimensions (mm) W X H X D	45 X 90 X 79									
Mass (g)	370									
Optional accessory	Auxiliary contact block	<input type="radio"/>								
	Alarm contact block	<input type="radio"/>								
	Auxiliary and alarm contact block	<input type="radio"/>								
	Short-circuit alarm contact block	<input type="radio"/>								
	Shunt trip device	<input type="radio"/>								
	Undervoltage trip device	<input type="radio"/>								
	External operating handle	<input type="radio"/>								
Standard	IEC 60947-1, 60947-2, 60947-4-1, UL 508, CSA C22.2 No.14									

Notes: *1 Replace the □ mark in the part number by current range codes.

Available Not available

*2 The BM3RHB is cUL listed as HP rated motor controllers.

*3 The BM3RHB is cUL listed for group Installation as per NEC430-53(C).

Manual Motor Starters

Quick Reference Guide

MSA CONTROL - (11) 3961-1171 - comercial@msacontrol.com.br

■ 63A Frame Types and Ratings

Adjustable thermal-magnetic trip type	Standard breaking capacity BM3VSB-□										
Number of poles	3										
Handle type	Rotary										
Rated current I _e (A)	10 to 63										
Rated operational voltage U _e (V)	200 to 690										
Rated frequency (Hz)	50/60										
Rated insulation voltage U _i (V)	1000										
Rated impulse withstand voltage U _{imp} (kV)	8										
Utilization category IEC 60947-2 Circuit breaker	Cat. A										
Utilization category IEC 60947-4-1 Motor starter	AC-3										
Trip class IEC 60947-4-1	10										
Instantaneous trip characteristic	13 x I _e max.										
Power loss (total of 3-pole)	11W: I _n =10 to 32A 15W: I _n =40 to 50A 17W: I _n =63A										
Mechanical durability (operations)	50,000										
Electrical durability (operations)	25,000										
Max. operations per hour (motor start-up)	25										
Phase-loss protection	Provided										
Trip indicator	Provided										
Test trip function	Provided										
Adjustable current range	UL/CSA 3phase HP rating (HP) * ²		Instantaneous trip current (A)	UL/CSA Short circuit current rating (kA) * ³	Maximum listed branch circuit protection * ³						
Code * ¹	I _e : Min.–Max. (A)	200-208VAC	220-240VAC	440-480VAC	550-600VAC			240VAC	480VAC	600VAC	Fuse or MCCB (A)
010	6.3–10	2	3	5	7-1/2	130	100	22	10	600	
013	9–13	3	3	7-1/2	10	169	100	22	10	600	
016	11–16	3	5	10	10	208	100	22	10	600	
020	14–20	5	5	10	15	260	100	22	10	600	
025	19-25	7-1/2	7-1/2	15	20	325	100	22	10	600	
032	24-32	10	10	20	30	416	100	22	10	600	
040	28-40	10	10	30	30	520	100	22	10	600	
050	35-50	15	15	30	40	650	100	22	10	600	
063	45-63	20	20	40	60	819	100	22	10	600	
Dimensions (mm) W X H X D	55 X 110 X 96										
Mass (g)	780										
Optional accessory	Auxiliary contact block	<input type="radio"/>									
	Alarm contact block	<input type="radio"/>									
	Auxiliary and alarm contact block	<input type="radio"/>									
	Short-circuit alarm contact block	<input type="radio"/>									
	Shunt trip device	<input type="radio"/>									
	Undervoltage trip device	<input type="radio"/>									
	External operating handle	<input type="radio"/>									
Standard	IEC 60947-1, 60947-2, 60947-4-1, UL 508, CSA C22.2 No.14										

Notes: *¹ Replace the □ mark in the part number by current range codes.

*² The BM3VSB is cUL listed as HP rated motor controllers.

*³ The BM3VSB is cUL listed for group Installation as per NEC430-53(C).

Available

Not available

Manual Motor Starters

Quick Reference Guide

MSA CONTROL - (11) 3961-1171 - comercial@msacontrol.com.br

63A Frame types and ratings

Adjustable thermal-magnetic trip type	High breaking capacity BM3VHB-□									
										
	AF01-43									
Number of poles	3									
Handle type	Rotary									
Rated current I _e (A)	10 to 63									
Rated operational voltage U _e (V)	200 to 690									
Rated frequency (Hz)	50/60									
Rated insulation voltage U _i (V)	1000									
Rated impulse withstand voltage U _{imp} (kV)	8									
Utilization category	IEC 60947-2 Circuit breaker: Cat. A IEC 60947-4-1 Motor starter: AC-3									
Trip class IEC 60947-4-1	10									
Instantaneous trip characteristic	13 x I _e max.									
Power loss (total of 3-pole)	11W: I _n =10 to 32A 15W: I _n =40 to 50A 17W: I _n =63A									
Mechanical durability (operations)	50,000									
Electrical durability (operations)	25,000									
Max. operations per hour (motor start-up)	25									
Phase-loss protection	Provided									
Trip indicator	Provided									
Test trip function	Provided									
Adjustable current range	UL/CSA 3phase HP rating (HP) *2				Instantaneous trip current (A)	UL/CSA Short circuit current rating (kA) *3			Maximum listed branch circuit protection *3	
Code *1	I _e : Min.–Max. (A)	200-208VAC	220-240VAC	440-480VAC		550-600VAC	240VAC	480VAC	600VAC	Fuse or MCCB (A)
010	6.3–10	2	3	5	7-1/2	130	100	50	10	600
013	9–13	3	3	7-1/2	10	169	100	50	10	600
016	11–16	3	5	10	10	208	100	50	10	600
020	14–20	5	5	10	15	260	100	50	10	600
025	19-25	7-1/2	7-1/2	15	20	325	100	50	10	600
032	24-32	10	10	20	30	416	100	50	10	600
040	28-40	10	10	30	30	520	100	50	10	600
050	35-50	15	15	30	40	650	100	50	10	600
063	45-63	20	20	40	60	819	100	50	10	600
Dimensions (mm) W x H x D	55 x 110 x 96									
Mass (g)	780									
Optional accessory	Auxiliary contact block	<input type="radio"/>								
	Alarm contact block	<input type="radio"/>								
	Auxiliary and alarm contact block	<input type="radio"/>								
	Short-circuit alarm contact block	<input type="radio"/>								
	Shunt trip device	<input type="radio"/>								
	Undervoltage trip device	<input type="radio"/>								
	External operating handle	<input type="radio"/>								
Standard	IEC 60947-1, 60947-2, 60947-4-1, UL 508, CSA C22.2 No.14									

Notes: *1 Replace the □ mark in the part number by current range codes.

*2 The BM3VHB is cUL listed as HP rated motor controllers.

*3 The BM3VHB is cUL listed for group Installation as per NEC430-53(C).

Available Not available

Manual Motor Starters

Type E Ratings

MSA CONTROL - (11) 3961-1171 - comercial@msacontrol.com.br

•BM3RSB (Type E ratings)

Manual motor starters		3 phase motor		Short circuit rating(kA)	
Code	Ie; Min-Max. (A)	Rated capacity (HP) 220-240V AC	Rated capacity (HP) 440-480V AC	up to 240V AC	up to 480/277V AC
P16	0.1-0.16	In accordance with Motor full load current		100	50
P25	0.16-0.25			100	50
P40	0.25-0.4			100	50
P63	0.4-0.63			100	50
001	0.63-1.0			100	50
1P6	1-1.6			3/4	100
2P5	1.6-2.5	1/2	1	100	50
004	2.5-4	3/4	2	100	50
6P3	4-6.3	1-1/2	3	100	50
010	6.3-10	3	5	100	22
013	9-13	3	7-1/2	100	22
016	11-16	5	10	100	22
020	14-20	5	10	100	22
025	19-25	7-1/2	15	50	22
032	24-32a	10	20	50	22

To make an application for use with Type E controller, you need to prepare BZ0TCRE and BZ0TKUAB accessories for BM3RSB separately.

•BM3RHB (Type E ratings)

Manual motor starters		3 phase motor		Short circuit rating(kA)	
Code	Ie; Min-Max. (A)	Rated capacity (HP) 220-240V AC	Rated capacity (HP) 440-480V AC	up to 240V AC	up to 480/277V AC
P16	0.1-0.16	In accordance with Motor full load current		100	50
P25	0.16-0.25			100	50
P40	0.25-0.4			100	50
P63	0.4-0.63			100	50
001	0.63-1.0			100	50
1P6	1-1.6			3/4	100
2P5	1.6-2.5	1/2	1	100	50
004	2.5-4	3/4	2	100	50
6P3	4-6.3	1-1/2	3	100	50
010	6.3-10	3	5	100	50
013	9-13	3	7-1/2	100	50
016	11-16	5	10	100	50
020	14-20	5	10	100	50
025	19-25	7-1/2	15	100	50
032	24-32	10	20	100	50

To make an application for use with Type E controller, you need to prepare BZ0TCRE and BZ0TKUAB accessories for BM3RHB separately.

•BM3VSB (Type E ratings)

Manual motor starters		3 phase motor		Short circuit rating(kA)	
Code	Ie; Min-Max. (A)	Rated capacity (HP) 220-240V AC	Rated capacity (HP) 440-480V AC	up to 240V AC	up to 480/277V AC
010	6.3-10	3	5	100	22
013	9-13	3	7-1/2	100	22
016	11-16	5	10	100	22
020	14-20	5	10	100	22
025	19-25	7-1/2	15	100	22
032	24-32	10	20	100	22
040	28-40	10	30	100	22
050	35-50	15	30	100	22
063	45-63	20	40	100	22

To make an application for use with Type E controller, you need to prepare BZ0TKUAB accessories for BM3VSB separately.

•BM3VHB (Type E ratings)

Manual motor starters		3 phase motor		Short circuit rating(kA)	
Code	Ie; Min-Max. (A)	Rated capacity (HP) 220-240V AC	Rated capacity (HP) 440-480V AC	up to 240V AC	up to 480/277V AC
010	6.3-10	3	5	100	50
013	9-13	3	7-1/2	100	50
016	11-16	5	10	100	50
020	14-20	5	10	100	50
025	19-25	7-1/2	15	100	50
032	24-32	10	20	100	50
040	28-40	10	30	100	50
050	35-50	15	30	100	50
063	45-63	20	40	100	50

To make an application for use with Type E controller, you need to prepare BZ0TKUAB accessories for BM3VHB separately.

Manual Motor Starters

Ordering Information and Characteristics

MSA CONTROL - (11) 3961-1171 - comercial@msacontrol.com.br

Ordering Information

Specify the following:

1. Part number
2. Accessories if required

BM3 V H B - 063

Product category

Frame size

R: 32A Frame 45mm wide

V: 63A Frame 55mm wide

Rated current code (see page 9 to 12)

Operating characteristic

B: Adjustable thermal-magnetic trip

Breaking capacity

S: Standard breaking capacity

H: High breaking capacity

Characteristic Curves

• BM3RSB, RHB

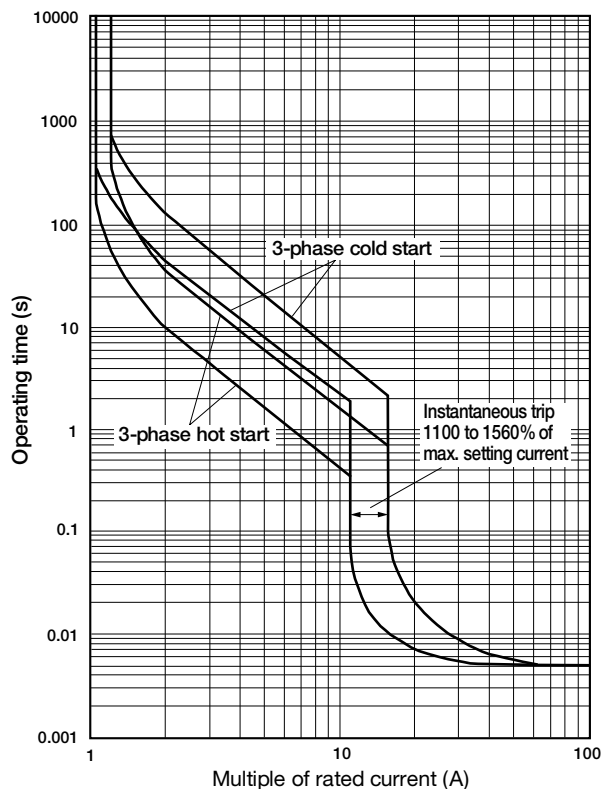

• BM3VSB, VHB

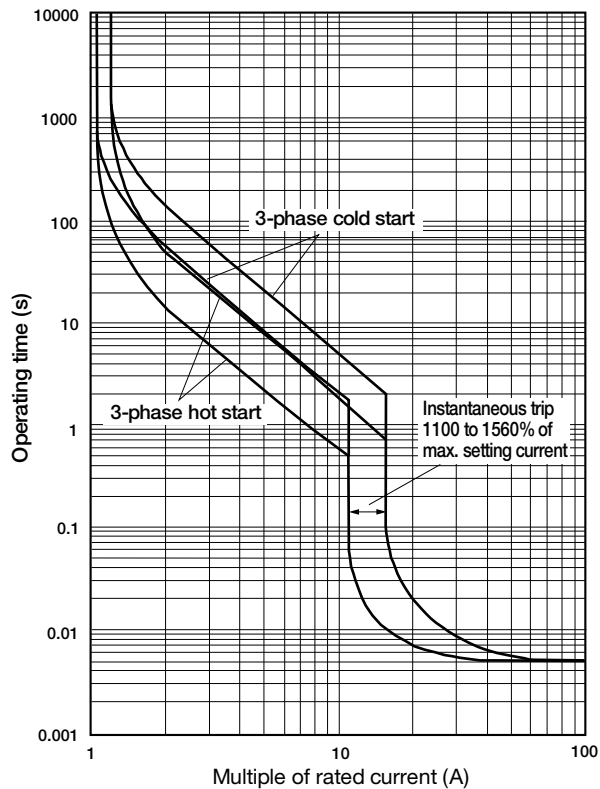

Manual Motor Starters

Optional Accessories

MSA CONTROL - (11) 3961-1171 - comercial@msacontrol.com.br

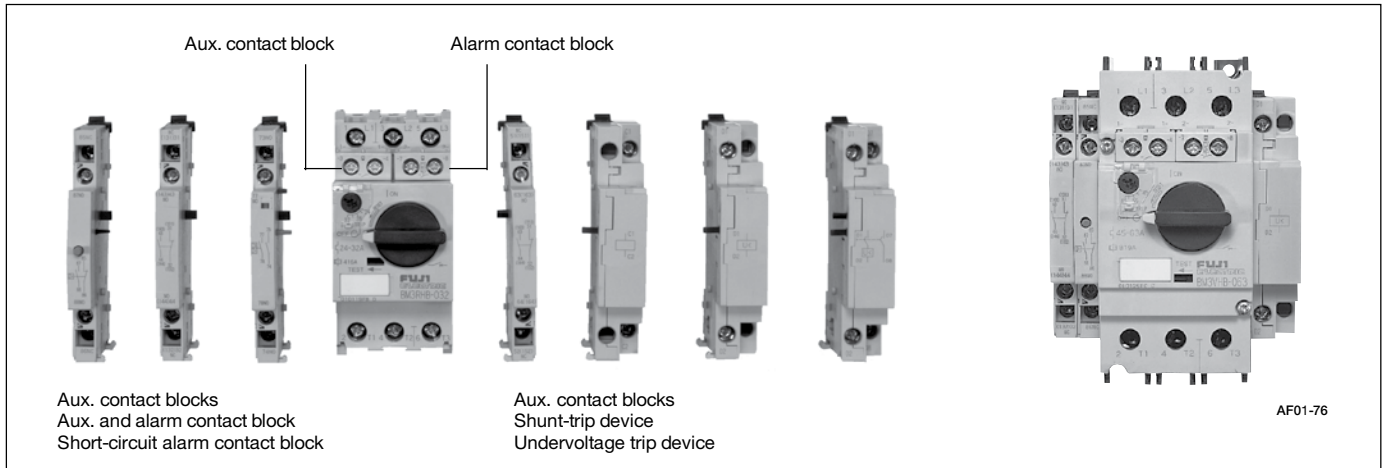

■ Features

- All accessories can be used with BM3R (45mm wide) and BM3V (55mm wide) frames.
- Accessories are easily mounted.
- Internal auxiliary contact blocks and alarm contact blocks can be mounted on front side.
- External auxiliary contact blocks can be mounted on either the right or left side.
- Shunt trip and undervoltage trip devices are available in a wide range of operating voltages.
- Standard and emergency external handles are available.
- IP20 terminal cover prevents accidental contact to electrically charged parts.



■ Part Number and Ratings

• Auxiliary Contact Blocks (W)

Description	Starter type	Mounting	Contact arrangement	Part number	Mass (g)
 AF01-60L  AF01-59, 01-58 These blocks are linked to the ON/OFF operation of the MMS. Up to two contact blocks can be mounted to the right/left front, and up to two contact blocks can be mounted to the right/left sides.	BM3R BM3V	Front	1NO 1NC	BZ0WIA BZ0WIB	9
		Left side	2NO 1NO+1NC 2NC	BZ0WUAAL BZ0WUABL BZ0WUBBL	45
		Right side	2NO 1NO+1NC 2NC	BZ0WUAAR BZ0WUABR BZ0WUBBR	45

• Alarm Contact Blocks (K)

Description	Starter type	Mounting	Contact arrangement	Part number	Mass (g)
 AF01-60R This block operates when the MMS trips due to overload, phase-loss, or short-circuit. It is not linked to the ON/OFF operation of the MMS. Note: Operation can be checked with the test trip function.	BM3R BM3V	Front (Right side only)	1NO 1NC	BZ0KIA BZ0KIB	9

Manual Motor Starters

Optional Accessories

MSA CONTROL - (11) 3961-1171 - comercial@msacontrol.com.br

• Auxiliary and Alarm Contact Blocks (WK)

Description	Starter type	Mounting	Contact arrangement	Part number	Mass (g)
 <p>AF01-57</p> <ul style="list-style-type: none"> This contact block combines auxiliary contact and alarm contact that operate in the event of an overload, phase loss, or short-circuit. Alarm contact is not linked to the ON/OFF operation of the MMS. An alarm is displayed in the contact block's indicator when the alarm contact operates. <p>Note: Operation can be checked with the test trip function.</p>	BM3R BM3V	Left	1NO (Aux.)+ 1NO (Alarm)	BZ0WKUAA	45
			1NC (Aux.)+ 1NO (Alarm)	BZ0WKUBA	
			1NO (Aux.)+ 1NC (Alarm)	BZ0WKUAB	
			1NC (Aux.)+ 1NC (Alarm)	BZ0WKUBB	

• Short-circuit Alarm Contact Block (KI)

Description	Starter type	Mounting	Contact arrangement	Part number	Mass (g)
 <p>AF01-56</p> <ul style="list-style-type: none"> The contacts operate only when the MMS has tripped due to a short-circuit. When these contacts operate, the blue reset button extends out, and a trip indication is displayed. The power to the MMS can be turned ON after pressing the reset button. <p>Note: Operation can be checked with the test trip function. Be sure to press the reset button before mounting to the MMS.</p>	BM3R BM3V	Left	1NO+1NC	BZ0TKUAB	45

• Shunt Trip Devices (F)

Description	Starter type	Mounting	Coil voltage	Part number	Mass (g)
 <p>AF01-55</p> <p>This device is used to remotely trip the MMS.</p> <p>Notes:</p> <ul style="list-style-type: none"> This device cannot be used together with an undervoltage trip device. When the MMS has been tripped with the shunt trip device, press the reset button before turning ON the power. 	BM3R BM3V	Right	24VAC 50/60Hz 48VAC 60Hz 48VAC 50Hz/60VAC 60Hz	BZ0FAZU BZ0FBZU BZ0FCZU	115
			100VAC 50Hz/100–110VAC 60Hz 110–127VAC 50Hz/120VAC 60Hz 200VAC 50Hz/200–220VAC 60Hz 220–230VAC 50Hz/240–260VAC 60Hz 240VAC 50Hz/277VAC 60Hz	BZ0F1ZU BZ0FDZU BZ0FEZU BZ0FFZU BZ0FGZU	
			380–400VAC 50Hz/400–440VAC 60Hz 415–440VAC 50Hz/460–480VAC 60Hz 500VAC 50Hz/600VAC 60Hz 24–60V DC * 110-240V DC *	BZ0FHZU BZ0F4ZU BZ0FJZU BZ0FKZUD BZ0FLZUD	

Note: * The time rating of coil is 5s.

• Undervoltage Trip Devices (R)



Description	Starter type	Mounting	Coil voltage	Part number	Mass (g)
 <p>AF01-54</p> <p>R types This device automatically trips the MMS when the control circuit voltage drops below the specified value.</p> <p>Notes:</p> <ul style="list-style-type: none"> This device cannot be used together with a shunt trip device. When the MMS has been tripped with the undervoltage trip device, press the reset button before turning ON the power. 	BM3R BM3V	Right	24VAC 50Hz 24VAC 60Hz 48VAC 50Hz 48VAC 60Hz	BZ0RAZ1U BZ0RAZ2U BZ0RBZ1U BZ0RBZU	115
			100VAC 50Hz/100–110VAC 60Hz 110–127VAC 50Hz/120VAC 60Hz 200VAC 50Hz/200–220VAC 60Hz 220–230VAC 50Hz/240–260VAC 60Hz 240VAC 50Hz/277VAC 60Hz	BZ0R1ZU BZ0RDZU BZ0REZU BZ0RFZU BZ0RGZU	
			380–400VAC 50Hz/400–440VAC 60Hz 415–440VAC 50Hz/460–480VAC 60Hz 500VAC 50Hz/600VAC 60Hz	BZ0RHZU BZ0R4ZU BZ0RJZU	

Manual Motor Starters

Optional Accessories

MSA CONTROL - (11) 3961-1171 - comercial@msacontrol.com.br



• External Operating Handles

Description	Starter type	Handle type	Part number	Mass (g)
 <p>KK02-305</p>  <p>KK02-306</p> <ul style="list-style-type: none"> •Used to operate an MMS installed inside a panel, from the outside of the panel. •Equipped with an interlock mechanism that prevents someone from mistakenly opening the panel door when the MMS is in the ON state. •The shaft can be cut to match the distance between the MMS and the panel door. •Door interlock function •OFF lock function •Can be locked OFF with up to three padlocks. Note: Padlocks not included. •Release screw allows the door to be opened with the handle in the ON position. •IP54 enclosure 	BM3RH	Standard (black)	BZ0VBBL	160
		Emergency (red/yellow)	BZ0VYRL	160
	BM3V	Standard (black)	BZ0VBBM	160
		Emergency (red/yellow)	BZ0VYRM	160

• Line Side Terminal Cover

Description	Starter type	Part number	Mass (g)
 <p>Used for making Type E or Type F condition</p>	BM3R	BZ0TCRE	30

• Others

Description	Starter type	Part number	Mass (g)
<p>Push-in lug</p>  <p>Used for screw mounting. 10 pcs/pack</p>	BM3R	BZ0SET	2.0
<p>Terminal cover for IP20</p>  <p>Prevents accidental contact to charged parts. 6 pcs/pack</p>	BM3V	BZ0TCV	0.6
<p>Dummy cover</p>  <p>KK02-39</p> <ul style="list-style-type: none"> •Used to cover the open space if an internally mounted accessory should become unnecessary. •Mounts to either the left-front or right-front position. •10 pcs/pack 	BM3R BM3V	BZ0CFG	1.4

Manual Motor Starters

Optional Accessories

MSA CONTROL - (11) 3961-1171 - comercial@msacontrol.com.br

■ Ratings of Accessories

Accessory type		Auxiliary contact block/front	Auxiliary contact block/side	Alarm contact block	Aux. and alarm contact block	Short-circuit alarm contact block
Part number		BZ0WI	BZ0WU	BZ0KI	BZ0WКУ	BZ0TKUAB
Standard		IEC 60947-5-1, UL 508				
Rated operational current (A)	48V AC AC-15	5	6	5	6	6
	125V AC	3	4	3	4	4
	230V AC	1.5	4	1.5	4	4
	400V AC	–	2.2	–	2.2	2.2
	500V AC	–	1.5	–	1.5	1.5
	690V AC	–	0.6	–	0.6	0.6
	48V DC DC-13	1.38	5	1.38	5	5
	110V DC	0.55	1.3	0.55	1.3	1.3
	220V DC	0.27	0.5	0.27	0.5	0.5
Contact rating code UL 508		B300 Q300	A600 P300	B300 Q300	A600 P300	A600 P300
Min. voltage and current		17V 5mA				

Accessory type		Shunt trip device	Undervoltage device
Part number		BZ0F	BZ0R
Standard		IEC 60947-1, UL 508	
Rated insulation voltage (V AC)	IEC 60947 UL 508	690 600	
No. of ON-OFF operations		5000	
Operating time (ms)		20	
Power consumption	Inrush (VA/W) Sealed (VA/W)	21/12 8/1.2	
Voltage range	Tripping voltage (V) Closing voltage (V)	0.7 to 1.1Ue –	0.35 to 0.7Ue 0.85 to 1.1Ue
Time rating of coil (s)		AC: Continuous DC: 5	AC: Continuous

Note: Ue: Rated Voltage

Manual Motor Starters

Optional Accessories

MSA CONTROL - (11) 3961-1171 - comercial@msacontrol.com.br

Available accessory configuration

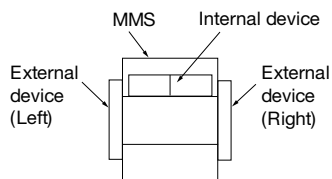

Internal devices

- Auxiliary contact block (W)
- Alarm contact block (K)

External devices

- Auxiliary contact (W2)
- Auxiliary and alarm contact block (WK)
- Short-circuit alarm contact block (KI)
- Shunt trip device (F)
- Undervoltage trip device (R)

Adj. thermal-magnetic trip type MMS		BM3RSB, BM3RHB						BM3VSB, BM3VHB					
Internal accessory													
External accessory													
W2 (Left)													
W2 (Right)													
WK (Left)													
KI (Left)													
F (Right)													
R (Right)													
W2 (Left)+F													
W2 (Left)+R													
WK+F													
WK+R													
KI+F													
KI+R													
W2 (Left)+W2 (Left)													
W2 (Left)+W2 (Right)													

Manual Motor Starters Optional Accessories

MSA CONTROL - (11) 3961-1171 - comercial@msacontrol.com.br

Available Accessory Configuration (continued)

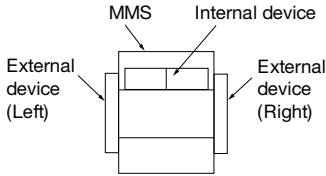

Internal devices

Auxiliary contact block (W) Alarm contact block (K)

External devices

Auxiliary contact (W2)

Auxiliary and alarm contact block (WK)

Short-circuit alarm contact block (KI)

Shunt trip device (F)

Undervoltage trip device (R)

Adj. thermal-magnetic trip type MMS		BM3RSB, BM3RHB						BM3VSB, BM3VHB						
Internal accessory														
			W	W	K	W+W	W+K		W	W	K	W+W	W+K	
External accessory	W2 (Right) + W2 (Right)													
		W2W2	W2W2W	W2W2W	W2W2K	W2W2WW	W2W2WK	W2W2	W2W2W	W2W2W	W2W2K	W2W2WW	W2W2WK	
	W2 (Left) + WK													
		W2WK	W2WKW	W2WKW	W2WKK	W2WKWW	W2WKWK	W2WK	W2WKW	W2WKW	W2WKK	W2WKWW	W2WKWK	W2WKWK
	W2 (Right) + WK													
		W2WK	W2WKW	W2WKW	W2WKK	W2WKWW	W2WKWK	W2WK	W2WKW	W2WKW	W2WKK	W2WKWW	W2WKWK	W2WKWK
	W2 (Left) + KI													
		W2KI	W2KIW	W2KIW	W2KIK	W2KIWW	W2KIWK	W2KI	W2KIW	W2KIW	W2KIK	W2KIWW	W2KIWK	W2KIWK
	W2 (Right) + KI													
		W2KI	W2KIW	W2KIW	W2KIK	W2KIWW	W2KIWK	W2KI	W2KIW	W2KIW	W2KIK	W2KIWW	W2KIWK	W2KIWK
	KI+WK													
		KIWK	KIWKW	KIWKW	KIWKK	KIWKWW	KIWKWK	KIWK	KIWKW	KIWKW	KIWKK	KIWKWW	KIWKWK	KIWKWK
	W2 (Left) + W2 (Left)+F													
		W2W2F	W2W2WF	W2W2WF	W2W2KF	W2W2WWF	W2W2WKF	W2W2F	W2W2WF	W2W2WF	W2W2KF	W2W2WWF	W2W2WKF	W2W2WKF
W2 (Left) + W2 (Left)+R														
	W2W2R	W2W2WR	W2W2WR	W2W2KR	W2W2WWR	W2W2WKR	W2W2R	W2W2WR	W2W2WR	W2W2KR	W2W2WWR	W2W2WKR	W2W2WKR	
W2 (Left) + WK+F														
	W2WKF	W2WKWF	W2WKWF	W2WKKF	W2WKWWF	W2WKWKF	W2WKF	W2WKWF	W2WKWF	W2WKKF	W2WKWWF	W2WKWKF	W2WKWKF	
W2 (Left) + WK+R														
	W2WKR	W2WKWR	W2WKWR	W2WKKR	W2WKWWR	W2WKWKR	W2WKR	W2WKWR	W2WKWR	W2WKKR	W2WKWWR	W2WKWKR	W2WKWKR	
W2 (Left) + KI+F														
	W2KIF	W2KIWF	W2KIWF	W2KIKF	W2KIWWF	W2KIWKF	W2KIF	W2KIWF	W2KIWF	W2KIKF	W2KIWWF	W2KIWKF	W2KIWKF	
W2 (Left) + KI+R														
	W2KIR	W2KIWR	W2KIWR	W2KIKR	W2KIWWR	W2KIWKR	W2KIR	W2KIWR	W2KIWR	W2KIKR	W2KIWWR	W2KIWKR	W2KIWKR	
KI+WK+F														
	KIWK	KIWKWF	KIWKWF	KIWKKF	KIWKWWF	KIWKWKF	KIWK	KIWKWF	KIWKWF	KIWKKF	KIWKWWF	KIWKWKF	KIWKWKF	
KI+WK+R														
	KIWK	KIWKWR	KIWKWR	KIWKKR	KIWKWWR	KIWKWKR	KIWK	KIWKWR	KIWKWR	KIWKKR	KIWKWWR	KIWKWKR	KIWKWKR	

Manual Motor Starters

Dimensions

MSA CONTROL - (11) 3961-1171 - comercial@msacontrol.com.br

■ Dimensions, mm

• Rocker handle types BM3RSB

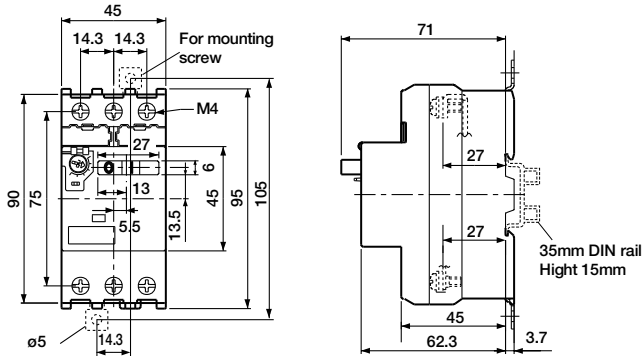

• Rotary handle types BM3RHB

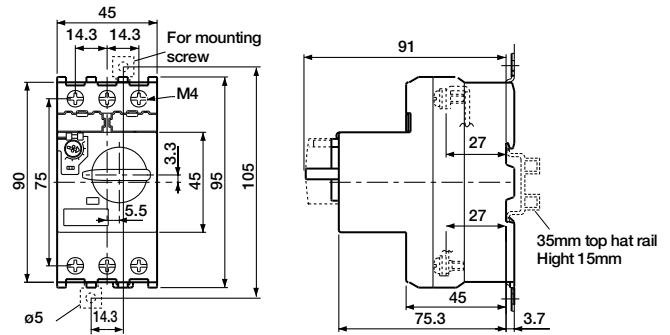

• Rotary handle types BM3VSB, BM3VHB

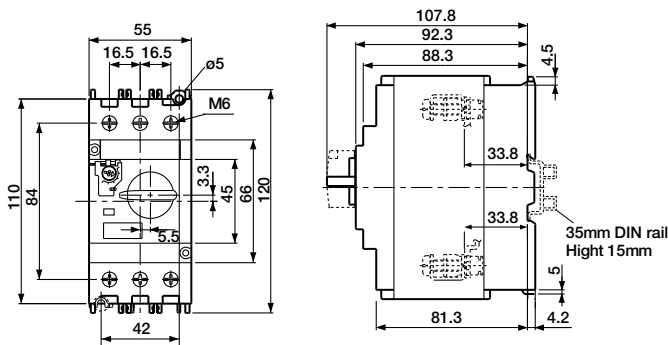

Accessories

• Auxiliary contact blocks, front mounting BZOWI

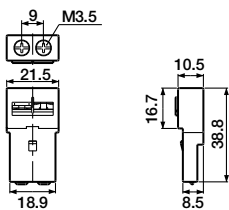

• Auxiliary contact blocks, side mounting BZOWU

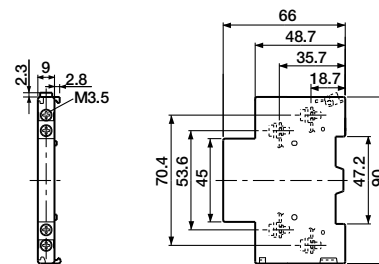

• Alarm contact blocks, front mounting BZOKI

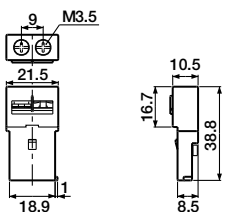

• Auxiliary and alarm contact blocks BZOWKU

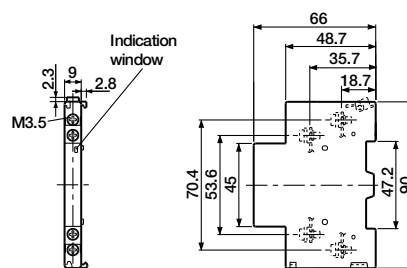

Manual Motor Starters Dimensions

MSA CONTROL - (11) 3961-1171 - comercial@msacontrol.com.br

■ Dimensions, mm

Accessories

- Short-circuit alarm contact block
BZ0TKUAB

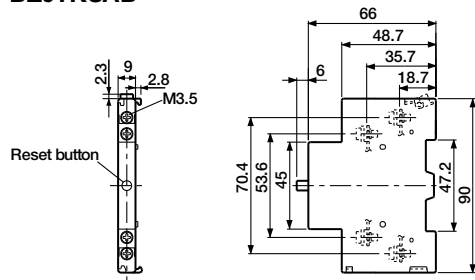

- Shunt trip devices BZ0F
Undervoltage trip devices BZ0R

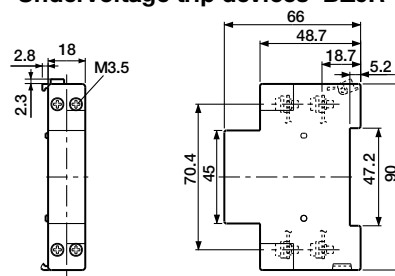

- BZ0TCRE

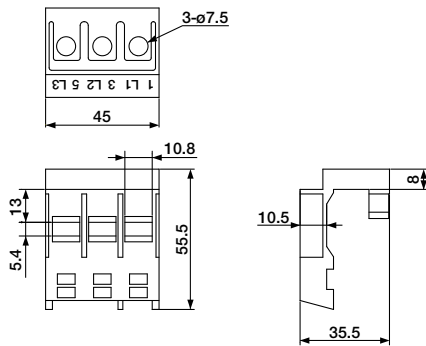

MMS with accessories

- BM3RSB + BZ0

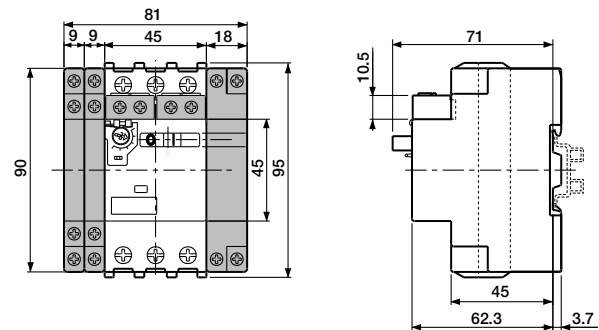

- BM3RHB + BZ0

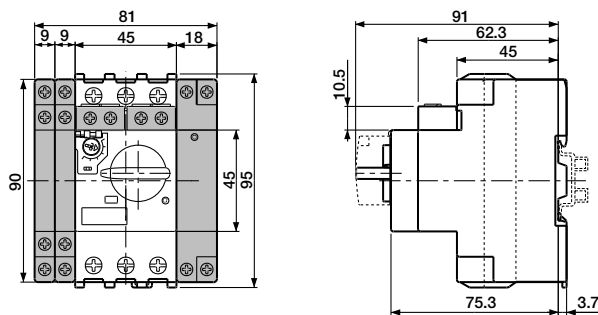

- BM3V□B + BZ0

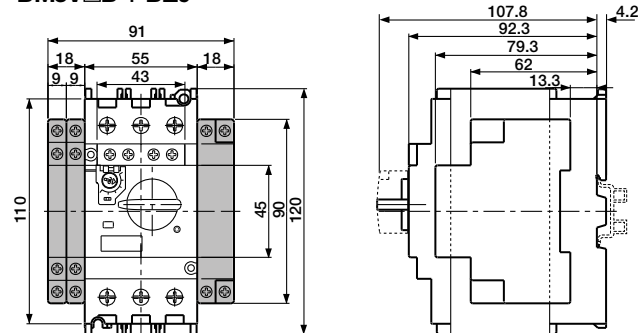

Type E construction

- BM3RSB

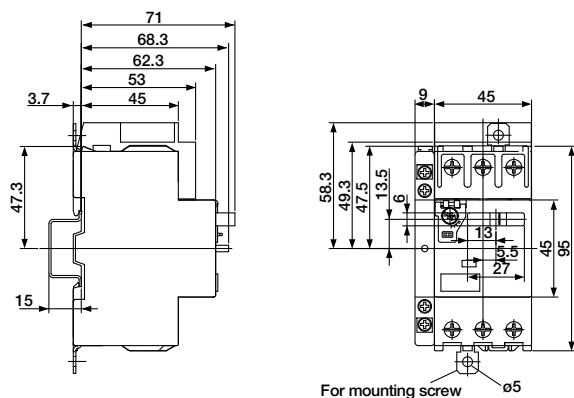

- BM3RHB

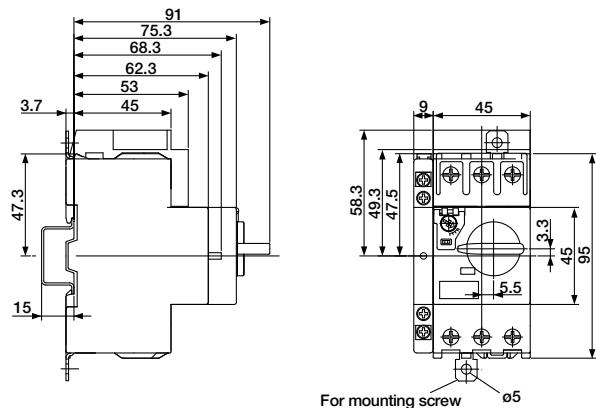

MMS	Line side terminal cover	Short-circuit alarm contact block	Mass (g)
BM3RSB	BZ0TCRE	BZ0TKUAB	425

MMS	Line side terminal cover	Short-circuit alarm contact block	Mass (g)
BM3RHB	BZ0TCRE	BZ0TKUAB	445

Manual Motor Starters

Dimensions

MSA CONTROL - (11) 3961-1171 - comercial@msacontrol.com.br

■ Dimensions, mm

Type E construction

• BM3VSB, BM3VHB

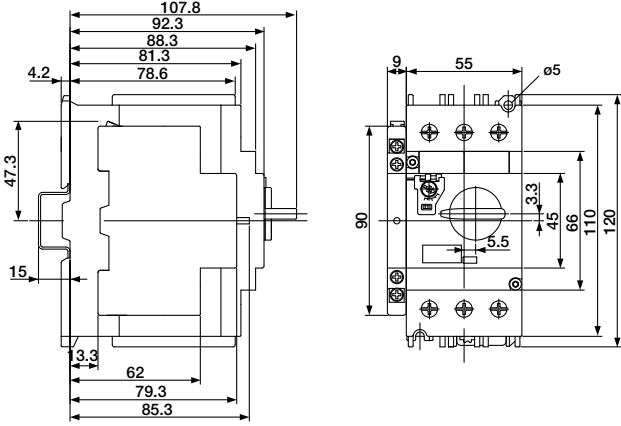

MMS	Line side terminal cover	Short-circuit alarm contact block	Mass (g)
BM3VSB,VHB	-	BZ0TKUAB	825

External operation handle BZ0V

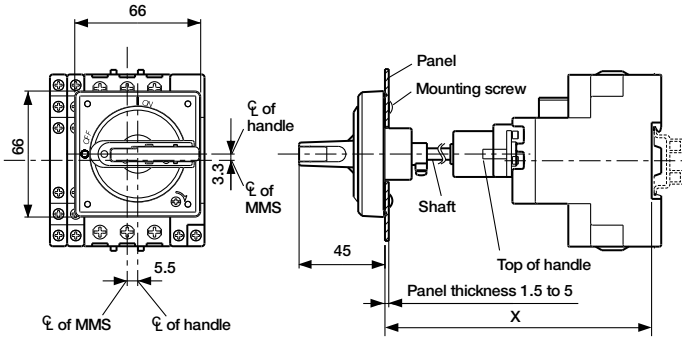

Type	X min.	X max.
BZ0VBBL, BZ0YRL	139 ±2	289 ±2
BZ0VBBM, BZ0YRM	156 ±2	306 ±2

Panel drilling

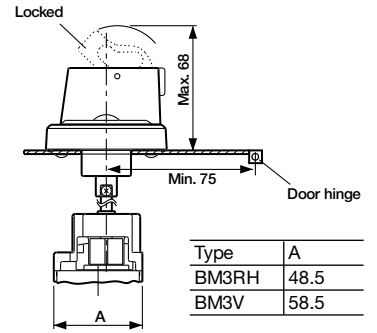
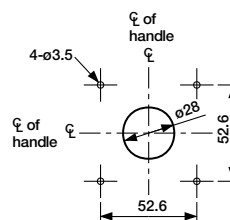

Type	A
BM3RH	48.5
BM3V	58.5

MSA CONTROL - (11) 3961-1171 - comercial@msacontrol.com.br

■ Wiring Diagrams

• MMS

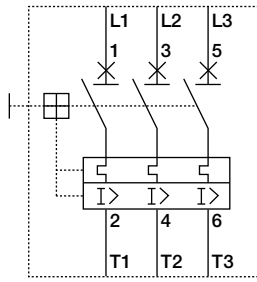

• Auxiliary contact blocks

Front mounting

BZ0WIA

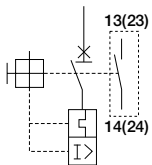

BZ0WIB

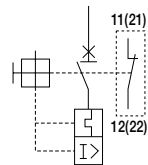

• Alarm contact blocks

Front mounting

BZ0KIA

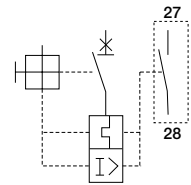

BZ0KIB

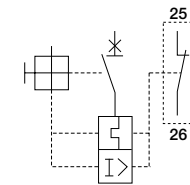

Side mounting

BZ0WUAAL

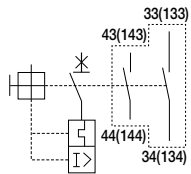

BZ0WUABL

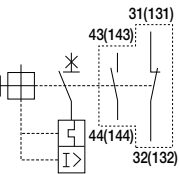

BZ0WUBBL

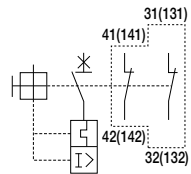

• Auxiliary and alarm contact blocks

BZ0WKUAA

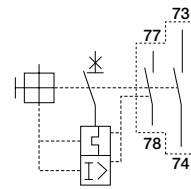

BZ0WKUBA

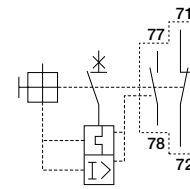

BZ0WUAAR

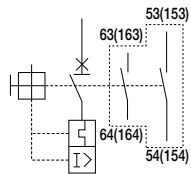

BZ0WUABR

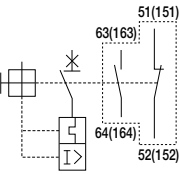

BZ0WUBBR

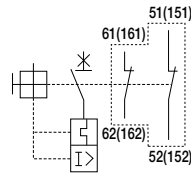

BZ0WKUAB

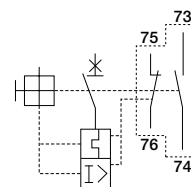

BZ0WKUBB

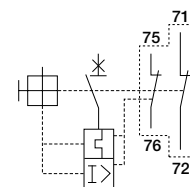

• Short-circuit alarm contact blocks

BZ0TKUAB

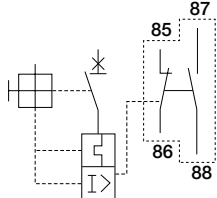

• Shunt trip devices

BZ0F

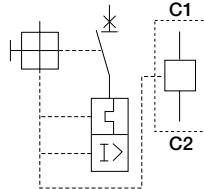

• Undervoltage trip devices

BZ0R

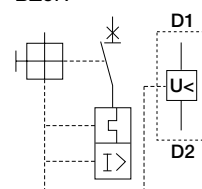

Manual Motor Starters

Instructions

MSA CONTROL - (11) 3961-1171 - comercial@msacontrol.com.br

Standard Operating Conditions

Ambient temperature	Operating: -5 to +55°C Storage: -40 to +65°C	No sudden temperature changes resulting in condensation or icing.
Humidity	45 to 85%RH	
Altitude	2000m or lower	
Atmosphere	No excessive dust, smoke, corrosive gases, flammable gases, steam or salt.	
Vibration	10 to 55Hz 15m/s ²	No abnormal shock or vibration
Shock	50m/s ²	

Mountings

• Rail mounting

The MMS can be mounted to a 35mm DIN rail. Secure the rail with screws at mounting pitch of less than 400mm for the BM3R type and less than 300mm for the BM3V type.

Applicable rail:

Use a 15mm-high TH35-15 (Fuji Electric model TH35-15AL) rail conforming to EN-50022 and IEC715.

The standard rail mounting direction is horizontal. When using the MMS on a vertically mounted rail, use Fuji Electric end clamp kits

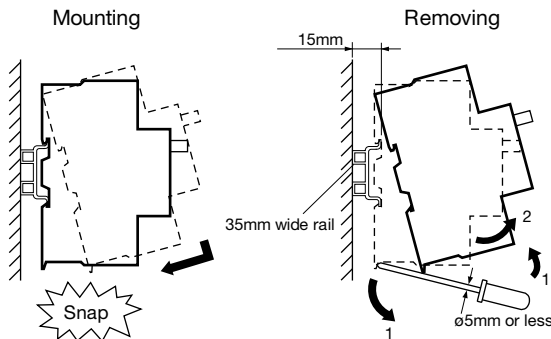

• Screw mounting

The separately sold push-in lug (BZ0SET) is required for screw mounting the BM3R frame. The BM3V frame can be screw mounted directly to the panel.

BM3RSB
BM3RHB

BM3VSB
BM3VHB

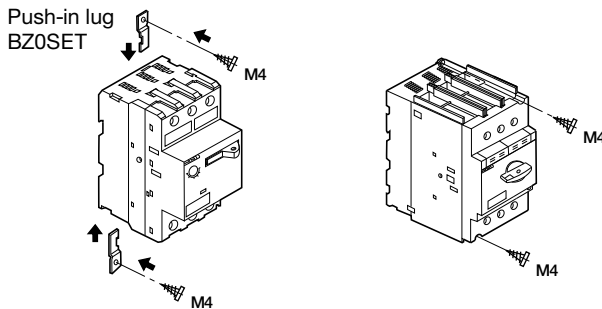

Mounting angle

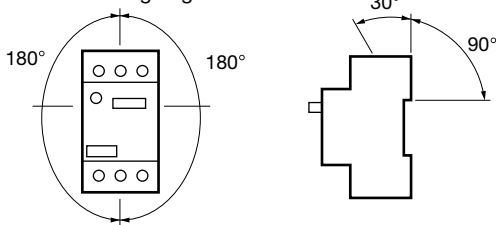

Arc Space

The arc space required when mounting is shown in the table below.

Type	Rated operational voltage U _e (V)	Min. distance to grounded metal (mm)	
		A, B	C, D
BM3RS	Up to 460	15	20
	500	15	30
	Up to 690	40	40
BM3RH	Up to 500	15	30
	Up to 690	40	50
BM3V	Up to 500	15	40
	Up to 690	40	50

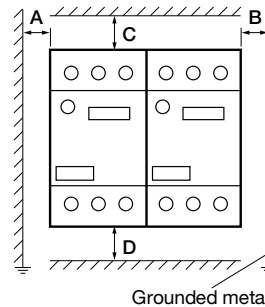

When frames are mounted side-by-side, operating conditions such as a high ambient temperature or using the maximum setting for continuous current may cause slight changes in operating characteristics due to temperature rises. Under such conditions, it is recommended that the frames be separated by at least 5mm.

Wirings

While pressing the wire with a screwdriver, tighten the screw to the specified tightening torque.

Type	BM3R	BM3V	BZ0 Accessories
Solid wire (mm)	ø1.6 to 2.6	ø1.6 to 2.6	ø1 to 1.6
Stranded wire (mm ²)	Single-wire	1 to 10	0.5 to 2.5
	2-wire	1 to 6	0.5 to 2.5
AWG	Single-wire	18 to 8	18 to 14
	2-wire	18 to 10	18 to 14
Sheath stripping length (mm)	Approx.10	Approx.13	Approx.10
Terminal screw	Pan head screw (PZ2)	Pan head screw (PZ2)	Pan head screw (PZ2)
	M4	M6	M3.5
Tightening torque (N·m)	2	4	0.8

Note: There is no need for a crimp terminal or any other terminal on the end of the connection wire.

Manual Motor Starters Busbar System

MSA CONTROL - (11) 3961-1171 - comercial@msacontrol.com.br

■ Features



- The busbar system reduces wiring time and saves floorspace.
- The busbar makes it easy to power from 2 to 5 manual motor starters – with no wiring needed.
- The 3-phase feed-in terminals are used to connect the wire for the power supply circuit.
- The busbar cover guards against accidental contact with non-connected busbar terminals (charged parts).

<Note>

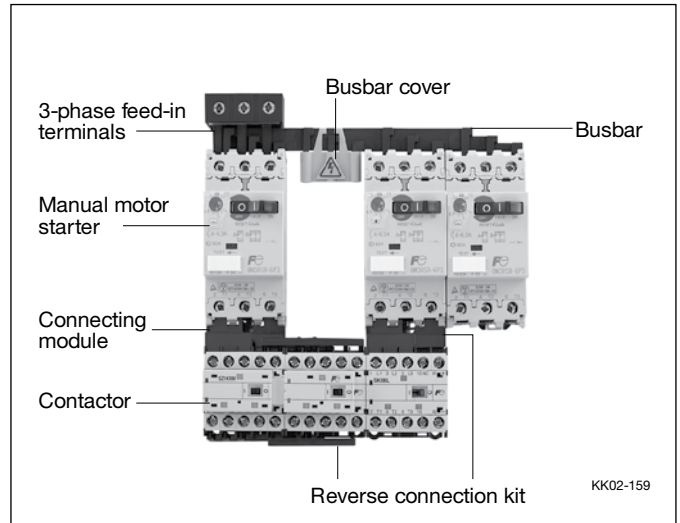
If using BZ0TCRE terminal cover with BM3R series MMS, the busbar system can not be used.

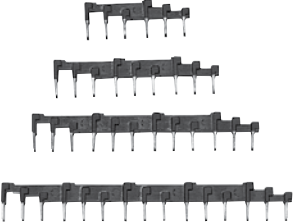
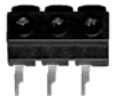

■ Part number and ratings

Description	Used with	Specification	Part number	Mass (g)
 KK02-164	BM3R	Continuous current: 64A max. Pin connection	2-BM3R, modular space: 45mm 3-BM3R, modular space: 45mm 4-BM3R, modular space: 45mm 5-BM3R, modular space: 45mm	BZ0BR02A 30 BZ0BR03A 50 BZ0BR04A 70 BZ0BR05A 90
	BM3R+1-external accessory, 9mm wide		2-BM3R, modular space: 54mm 3-BM3R, modular space: 54mm 4-BM3R, modular space: 54mm 5-BM3R, modular space: 54mm	BZ0BR12A 30 BZ0BR13A 55 BZ0BR14A 80 BZ0BR15A 105
	BM3R+2-external accessory, 9mm wide or BM3R+1-external accessory, 18mm wide	Continuous current: 64A max. Fork connection	2-BM3R, modular space: 63mm 4-BM3R, modular space: 63mm	BZ0BR22A 45 BZ0BR24A 100
	BM3V	Continuous current: 126A max. Pin connection	2-BM3V, modular space: 55mm 3-BM3V, modular space: 55mm 4-BM3V, modular space: 55mm	BZ0BV02A 140 BZ0BV03A 240 BZ0BV04A 340
	BM3V+1-external accessory, 9mm wide		2-BM3V, modular space: 64mm 3-BM3V, modular space: 64mm 4-BM3V, modular space: 64mm	BZ0BV12A 150 BZ0BV13A 270 BZ0BV14A 380
	BM3V+2-external accessory, 9mm wide or BM3V+1-external accessory, 18mm wide		2-BM3V, modular space: 73mm 4-BM3V, modular space: 73mm	BZ0BV22A 165 BZ0BV24A 425
3-phase feed-in terminal  AF01-70R	BM3R	Continuous current: 64A max. Applicable cable size: 25mm ² max.	BZ0BFRA	40
	BM3V	Continuous current: 126A max. Applicable cable size: 50mm ² max.	BZ0BFVA	170
Busbar cover  AF01-70L	BZ0BR	For pin connection For fork connection	BZ0BCRA BZ0BCRB	10 5
	BZ0BV	For pin connection	BZ0BCVA	5

Manual Motor Starters

Busbar System

MSA CONTROL - (11) 3961-1171 - comercial@msacontrol.com.br

■ Dimensions, mm

• For BM3R

BZ0BR0 Without external accessory

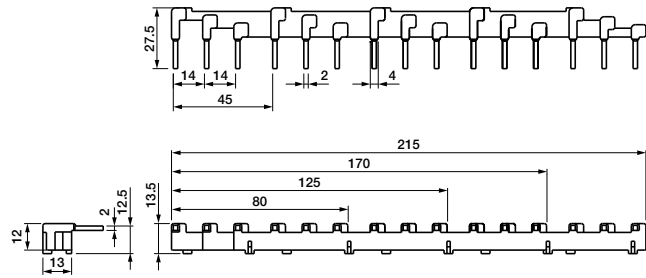

BZ0BR02A: 80mm
 BZ0BR03A: 125mm
 BZ0BR04A: 170mm
 BZ0BR05A: 215mm

• For BM3V

BZ0BV0 Without external accessory

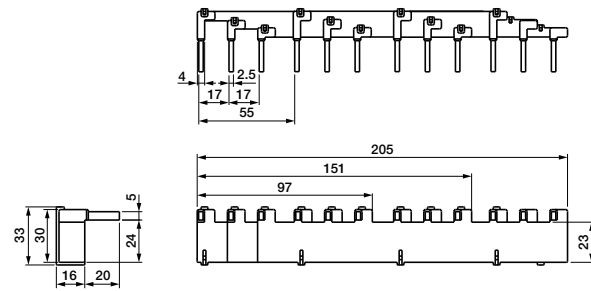

BZ0BV02A: 97mm
 BZ0BV03A: 151mm
 BZ0BV04A: 205mm

BZ0BR1 With 1-external accessory

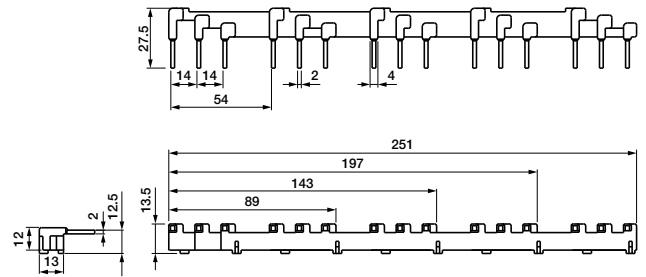

BZ0BR12A: 89mm
 BZ0BR13A: 143mm
 BZ0BR14A: 197mm
 BZ0BR15A: 251mm

BZ0BV1 With 1-external accessory, 9mm wide

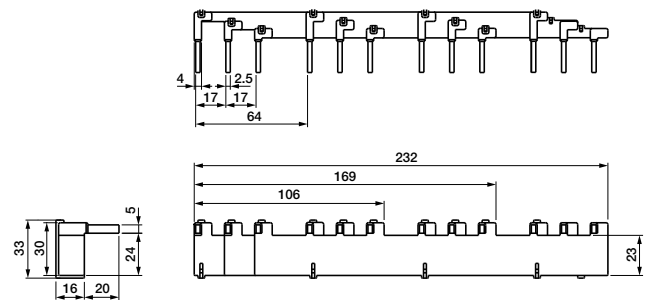

BZ0BV12A: 106mm
 BZ0BV13A: 169mm
 BZ0BV14A: 232mm

BZ0BR2 With 2-external accessory, 9mm wide
 With 1-external accessory, 18mm wide

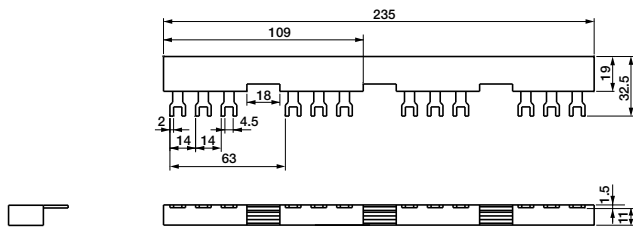

BZ0BR22A: 109mm
 BZ0BR24A: 235mm

BZ0BV2 With 2-external accessory, 9mm wide
 With 1-external accessory, 18mm wide

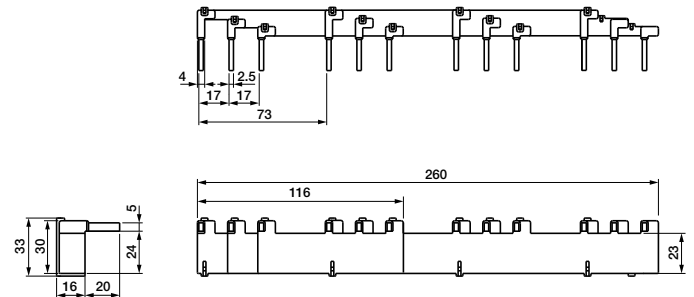

BZ0BV22A: 116mm
 BZ0BV24A: 260mm

MSA CONTROL - (11) 3961-1171 - comercial@msacontrol.com.br

■ Dimensions, mm
• 3-phase feed-in terminals
BZ0BFRA

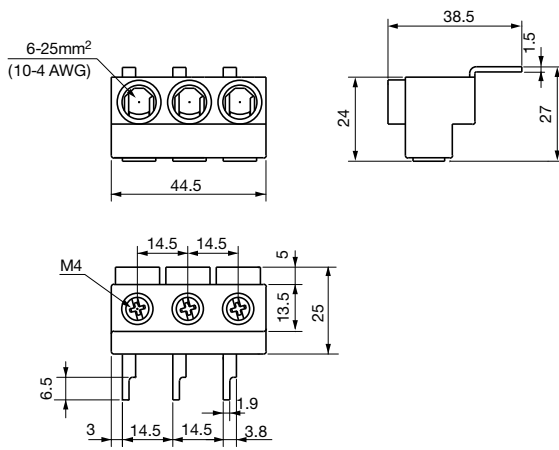

BZ0BFVA

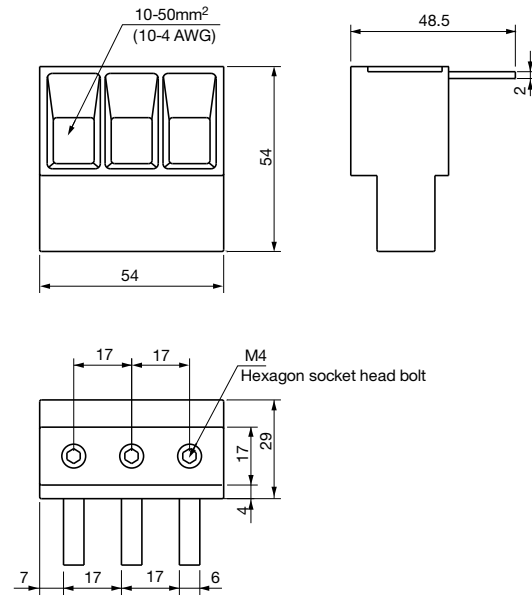

Manual Motor Starters Enclosures

MSA CONTROL - (11) 3961-1171 - comercial@msacontrol.com.br

■ Features

- Accommodates a variety of manual motor starters (BM3RSB-P16 to 025). Put the manual motor starter inside an enclosure for use in harsh environments. Surface mounting and flush mounting types available.
- IP41 and IP55 enclosure protection degree available.
- Manual motor starters (BM3RSB-P16 to 025) equipped with internal accessories and the following external accessories can be used inside an enclosure:
 Left side: One auxiliary contact block (W) or one auxiliary and alarm contact block (WK)
 Right side: One shunt trip device (F) or one undervoltage trip device (R)
- A wide variety of enclosure accessories are available. Padlocking device, emergency mushroom head pushbutton, conversion kit, and indicator lamps.

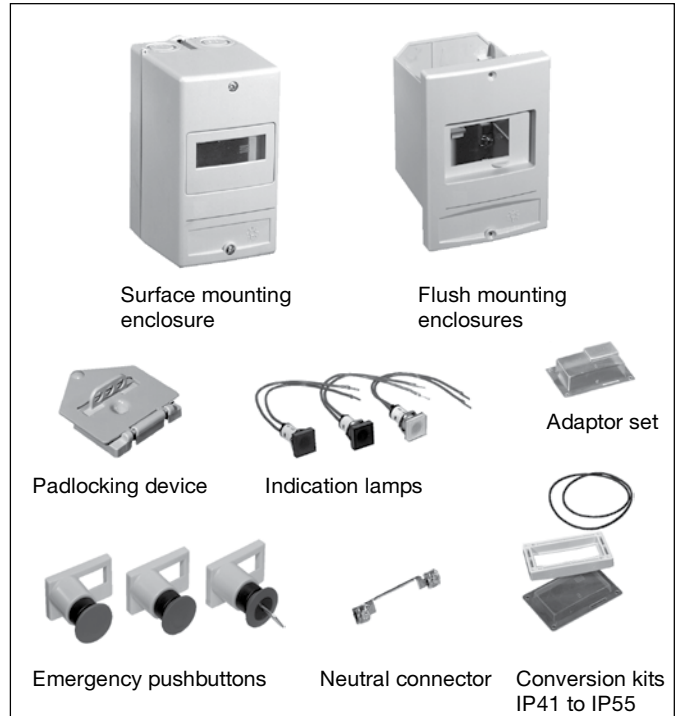

■ Part number and ratings

Enclosures for BM3RSB-P16 to 025

Mounting	Specification	Part number	Mass (g)
Surface	IP41	BZ0CSLA	320
	IP55 (with conversion kit)	BZ0CSLB	340
Flush	IP41	BZ0CFLA	240
	IP55 (with conversion kit)	BZ0CFLB	260

Accessories for enclosures

Description	Specification	Part number	Mass (g)
Padlocking device	OFF locking possible using up to three padlocks with a 5 to 8mm shackle diameter.	BZ0CKA	90
Emergency pushbutton	Momentary Push-lock turn reset Key operated	BZ0CPM	55
		BZ0CPL	55
		BZ0CPK	90
Conversion kit	Converts IP41 to IP55	BZ0CCA	25
Adaptor set	For BM3RS + undervoltage trip device with auxiliary contact.	BZ0CUA	20
Neutral connector	Used inside the enclosure for neutral and ground connection.	BZ0CNA	10
Indication lamp	Green, 100–120V AC	BZ0CLGA	15
	Green, 200–240V AC	BZ0CLGB	15
	Green, 380–440V AC	BZ0CLGC	15
	Green, 480–500V AC	BZ0CLGD	15
	Green, 500–600V AC	BZ0CLGE	15
	Red, 100–120V AC	BZ0CLRA	15
	Red, 200–240V AC	BZ0CLRB	15
	Red, 380–440V AC	BZ0CLRC	15
	Red, 480–500V AC	BZ0CLRD	15
	Red, 500–600V AC	BZ0CLRE	15
	White, 100–120V AC	BZ0CLCA	15
	White, 200–240V AC	BZ0CLCB	15
	White, 380–440V AC	BZ0CLCC	15
	White, 480–500V AC	BZ0CLCD	15
	White, 500–600V AC	BZ0CLCE	15

Notes: • The padlocking device cannot be used together with the emergency pushbutton or undervoltage trip device with auxiliary contact.
 • The emergency pushbutton cannot be used together with the undervoltage trip device with auxiliary contact.

Manual Motor Starters Dimensions

MSA CONTROL - (11) 3961-1171 - comercial@msacontrol.com.br

■ Dimensions, mm

• Surface Mounting For without Accessory

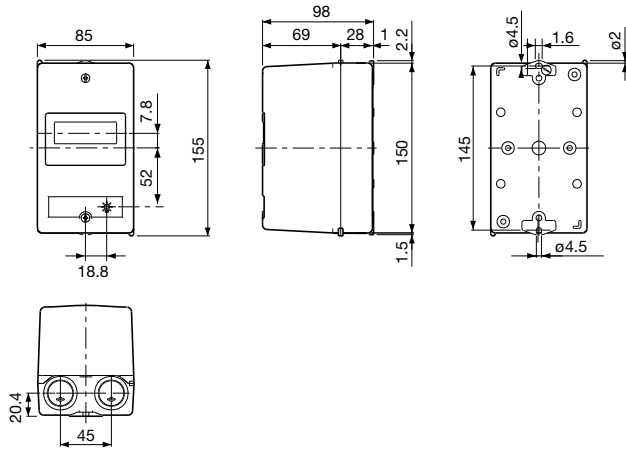

• Flush mounting For without Accessory

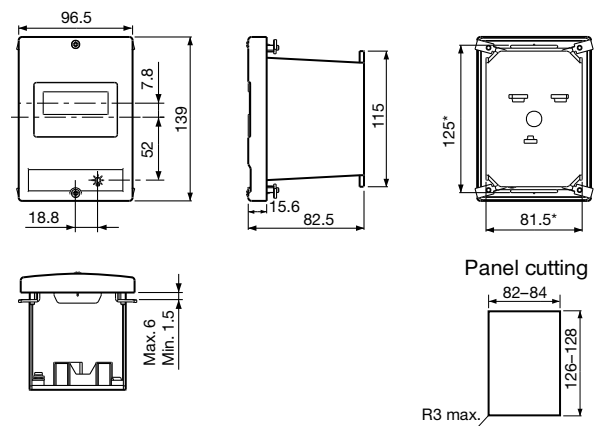

For with Padlocking Device

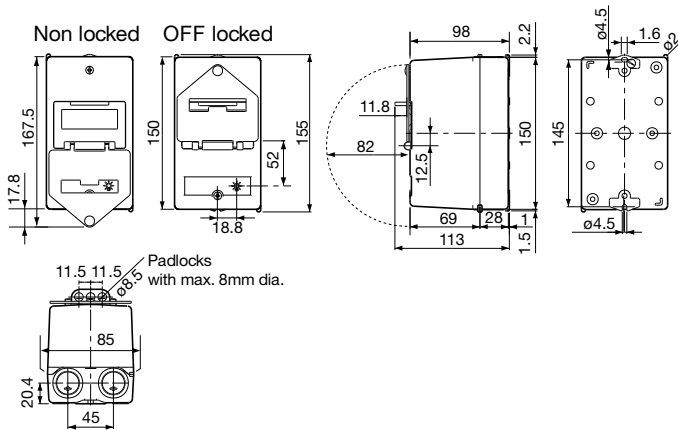

For with Padlocking Device

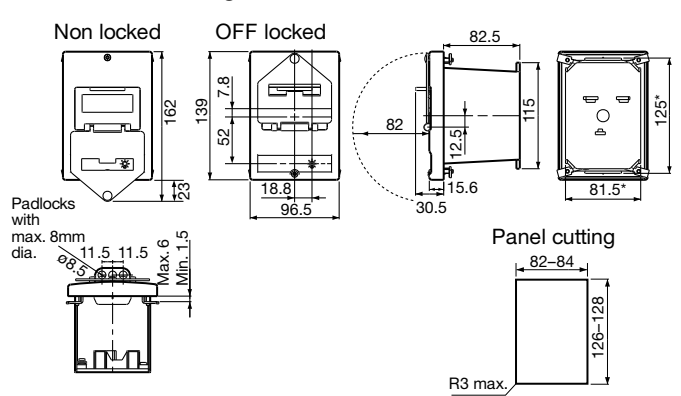

For with Emergency Pushbutton

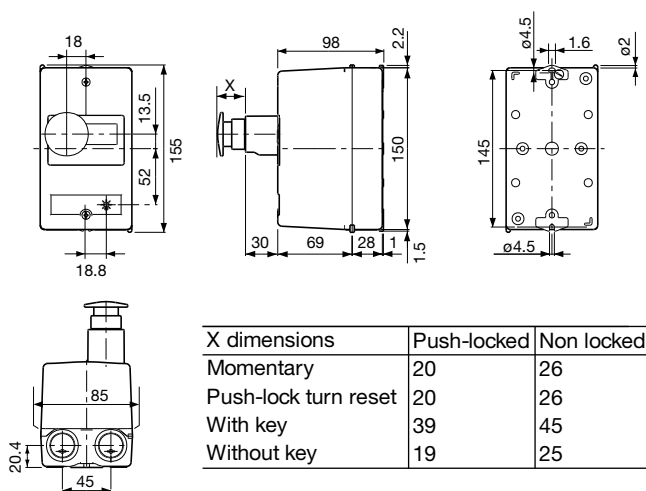

For with Emergency Pushbutton

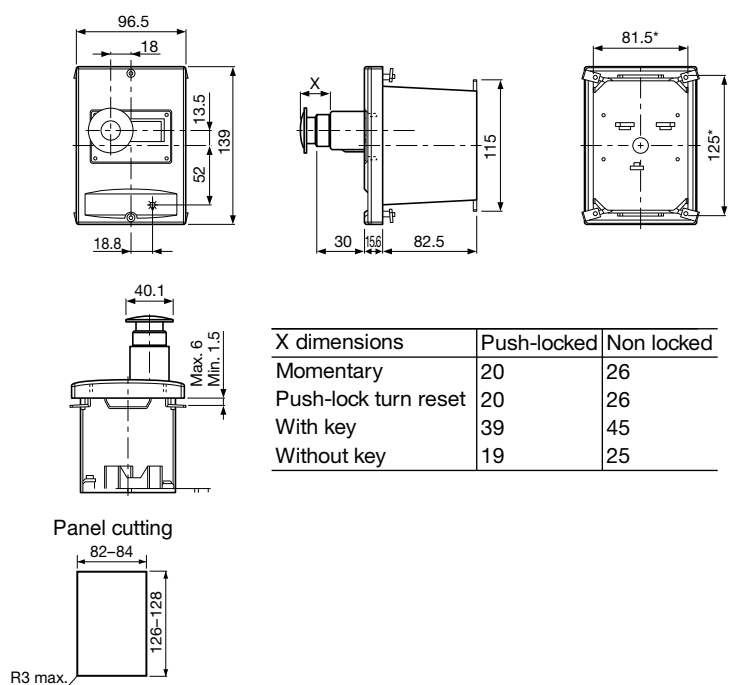

Contactors SK and SC-E series

General Information

MSA CONTROL - (11) 3961-1171 - comercial@msacontrol.com.br

3 to 100HP at 480V AC

The SK and SC-E series further enhance the high reliability of the SC series with full conformance to International standards.

In addition to the five basic concepts of the existing SC series magnetic contactors and motor starters — international standardization, compactness, safety, utility, and ecology — the SK and SC-E series take the line-up to the next step in utility with a new finger protection terminal and box lug terminal construction.

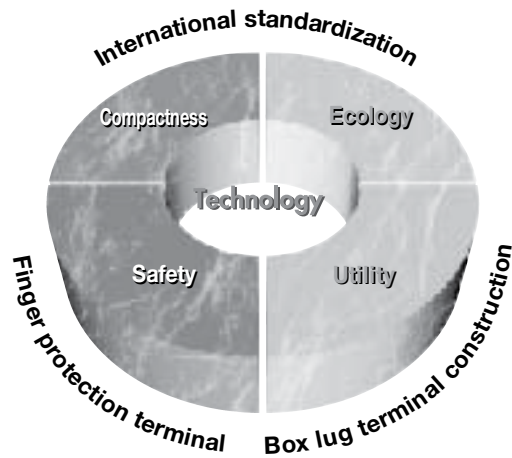

International standardization

IEC 60947-4-1, EN 60947-4-1, VDE 0660
UL 508, CSA C 22.2, JIS C 8201-4-1
[Approved cUL (File No. E42419, E44592),
TÜV (R2018010, R2150072, R50013402)]

Compactness

- SK06, SK09, SK12 : 45mm wide
- SC-E02 to E05: 43mm wide, SC-E1 to E2S: 54mm wide
- SC-E3, E4: 67mm wide, SC-E5: 88mm wide
- SC-E6: 100mm wide, SC-E7: 115mm wide
- Reducing mounting area

Safety

- Terminals with finger-touch protection (DIN 57106/
VDE 0106 Teil100)

Utility

- Box lug terminal construction
- Long electrical life
- Reduction of wiring work

Ecology

- Reducing power consumption
- Recycled thermoplastic resin used for plastic parts
- The names of materials are indicated on all major parts to facilitate their recycling

SK series

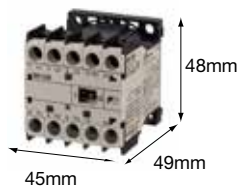

SK06, 09, 12

SC-E series



SC-E1 to E2S

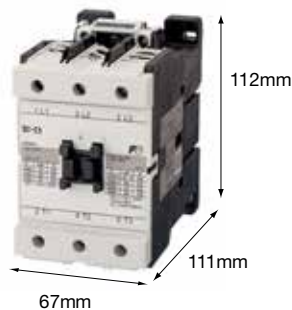

SC-E3, E4

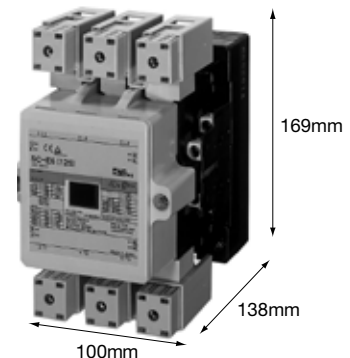

















SC-E6 with SUPER magnet

Contactors SK and SC-E series

Quick Reference Guide



















MSA CONTROL - (11) 3961-1171 - comercial@msacontrol.com.br

Contactor	AC operating	SK06A	SK09A	SK12A	SC-E02	SC-E03	SC-E04	SC-E05			
	DC operating	SK06G(2.4W)	SK09G(2.4W)	SK12G(2.4W)	SC-E02/G	SC-E03/G	SC-E04/G	SC-E05/G			
		SK06L(1.2W)	SK09L(1.2W)	SK12L(1.2W)							
						AF01-12	AF01-11	AF01-10	KK01-105		
Rating of 3-phase motor (HP)											
200V		1-1/2	2	3	2	3	5	5			
220-240V		2	3	3	2	3	5	7 1/2			
400-480V		3	5	5	5	7 1/2	10	15			
550-600V		3	5	5	5	7 1/2	10	15			
Rated operational current (A)											
200V		6.9	7.8	11	7.8	11	17.5	17.5			
220-240V		6.8	9.6	9.6	6.8	9.6	15.2	22			
400-480V		4.8	7.6	7.6	7.6	11	14	21			
550-600V		6.1	6.1	6.1	6.1	9	11	17			
Rated thermal current AC-1 (A)		20	20	20	20	20	25	32			
Auxiliary contact		1NO, 1NC	1NO, 1NC	1NO, 1NC	-	-	-	-			
Dimensions W×H×D (mm)	AC operated	45×48×49			43×80×81						
	DC operated	45×48×49			43×80×108						
Standard		IEC 60947-1, EN 60947-4-1, VDE 0660, UL 508, CSA C22.2									
Thermal overload relay		TK12	TK12	TK12	TK26E	TK26E	TK26E	TK26E			
											
					KKD14-114	KKD14-114	KKD14-114	KKD14-114			
Ampere setting range (A)		0.1-0.15	0.1-0.15	0.1-0.15	0.1-0.15	0.1-0.15	0.1-0.15	0.1-0.15			
		0.13-0.2	0.13-0.2	0.13-0.2	0.13-0.2	0.13-0.2	0.13-0.2	0.13-0.2			
		0.18-0.27	0.18-0.27	0.18-0.27	0.18-0.27	0.18-0.27	0.18-0.27	0.18-0.27			
		0.24-0.36	0.24-0.36	0.24-0.36	0.24-0.36	0.24-0.36	0.24-0.36	0.24-0.36			
		0.34-0.52	0.34-0.52	0.34-0.52	0.34-0.52	0.34-0.52	0.34-0.52	0.34-0.52			
		0.48-0.72	0.48-0.72	0.48-0.72	0.48-0.72	0.48-0.72	0.48-0.72	0.48-0.72			
		0.64-0.96	0.64-0.96	0.64-0.96	0.64-0.96	0.64-0.96	0.64-0.96	0.64-0.96			
		0.8-1.2	0.8-1.2	0.8-1.2	0.8-1.2	0.8-1.2	0.8-1.2	0.8-1.2			
		0.95-1.45	0.95-1.45	0.95-1.45	0.95-1.45	0.95-1.45	0.95-1.45	0.95-1.45			
		1.1-1.65	1.1-1.65	1.1-1.65	1.1-1.65	1.1-1.65	1.1-1.65	1.1-1.65			
		1.4-2.1	1.4-2.1	1.4-2.1	1.4-2.1	1.4-2.1	1.4-2.1	1.4-2.1			
		1.7-2.6	1.7-2.6	1.7-2.6	1.7-2.6	1.7-2.6	1.7-2.6	1.7-2.6			
		2.2-3.4	2.2-3.4	2.2-3.4	2.2-3.4	2.2-3.4	2.2-3.4	2.2-3.4			
		2.8-4.2	2.8-4.2	2.8-4.2	2.8-4.2	2.8-4.2	2.8-4.2	2.8-4.2			
		4-6	4-6	4-6	4-6	4-6	4-6	4-6			
			5-7.5	5-7.5	5-7.5	5-7.5	5-7.5	5-7.5			
			6-9	6-9	6-9	6-9	6-9	6-9			
				7-10.5	7-10.5	7-10.5	7-10.5	7-10.5			
				9-13			9-13	9-13			
							12-18	12-18			
								16-22			
								20-26			
Dimensions W×H×D (mm)		45×61.5×55			53×60.5×80.5						
Standard		IEC 60947-1, EN 60947-4-1, VDE 0660, UL 508, CSA C22.2									

Contactors SK and SC-E series

Quick Reference Guide

MSA CONTROL - (11) 3961-1171 - comercial@msacontrol.com.br

Contactors	AC operating	SC-E1	SC-E2	SC-E2S	SC-E3	SC-E4	SC-E5	SC-E6	SC-E7	
	DC operating	SC-E1/G	SC-E2/G	SC-E2S/G	SC-E3/G	SC-E4/G				
										
			AF01-8	AF01-7	AF01-6	AF01-5	AF01-4	AF01-3	AF01-2	AF01-1
Rating of 3-phase motor (HP)										
200V		7 1/2	10	15	20	25	30	40	50	
220-240V		10	15	20	25	30	30	40	50	
400-480V		25	30	30	50	50	60	75	100	
550-600V		25	30	30	50	50	75	100	125	
Rated operational current (A)										
200V		25.3	32.2	48.3	63.1	78.2	92	119.6	149.5	
220-240V		28	42	54	68	80	80	104	130	
400-480V		34	40	40	65	65	77	96	124	
550-600V		27	32	32	52	52	77	99	125	
Rated thermal current AC-1(A)		50	60	65	100	105	150	150	200	
Auxiliary contact		-	-	-	-	-	2NO+2NC	2NO+2NC	2NO+2NC	
Dimension W×H×D (mm)	AC operated	54×90×96				67×112×111		88×155×132	100×169×13	115×175×140
	DC operated	54×90×121.5				67×112×130				
Standard		IEC 60947-1, EN 60947-4-1, VDE 0660, UL 508, CSA C22.2								
Thermal overload relay		TK-E2	TK-E2	TK-E2	TK-E3	TK-E3	TK-E5	TK-E6	TK-E6	
										
		KK01-88	KK01-88	KK01-88	KK01-87	KK01-87	KK01-85	KK01-84	KK01-84	
Ampere setting range(A)										
		4-6	4-6	4-6	7-11	7-11	18-26	45-65	45-65	
		5-8	5-8	5-8	9-13	9-13	24-36	53-80	53-80	
		6-9	6-9	6-9	12-18	12-18	28-40	65-95	65-95	
		7-11	7-11	7-11	18-26	18-26	34-50	85-125	85-125	
		9-13	9-13	9-13	24-36	24-36	45-65		110-160	
		12-18	12-18	12-18	28-40	28-40	65-95			
		18-26	18-26	18-26	34-50	34-50	85-105			
		24-36	24-36	24-36	45-65	45-65				
			32-42		48-68	48-68				
				40-50	64-80					
				44-54						
Dimensions W×H×D (mm)		54×78.5×97				68×89.5×107.5		76.5×105×106	100×122×123	
Standard		IEC 60947-1, EN 60947-4-1, VDE 0660, UL 508, CSA C22.2								

Contactors SC-E series

Ordering Information and Characteristics

MSA CONTROL - (11) 3961-1171 - comercial@msacontrol.com.br

■ Available Coil

• AC coil, SC-E02 to SC-E4

Code	Coil operating voltage and frequency
24VAC	24V AC 50Hz / 24–26V AC 60Hz
48VAC	48V AC 50Hz / 48–52V AC 60Hz
100VAC	100V AC 50Hz / 100–110V AC 60Hz
110VAC	100–110V AC 50Hz / 110–120V AC 60Hz
120VAC	110–120V AC 50Hz / 120–130V AC 60Hz
200VAC	200V AC 50Hz / 200–220V AC 60Hz
220VAC	200–220V AC 50Hz / 220–240V AC 60Hz
400VAC	380–400V AC 50Hz / 400–440V AC 60Hz
440VAC	415–440V AC 50Hz / 440–480V AC 60Hz
500VAC	480–500V AC 50Hz / 500–550V AC 60Hz

• DC coil, SC-E02/G to SC-E4/G

Code	Coil operating voltage
12VDC	12V DC
24VDC	24V DC
48VDC	48V DC
100VDC	100V DC
110VDC	110V DC
200VDC	200V DC

• Super Magnet Coil, SC-E5 to SC-E7

Code	Coil operating voltage and frequency
24V	24–25V AC 50/60Hz, 24V DC
48V	48–50V AC 50/60Hz, 48V DC
100V	100–127V AC 50/60Hz, 100–120V DC
200V	200–250V AC 50/60Hz, 200–240V DC
400V	380–450V AC 50/60Hz
500V	460–575V AC 50/60Hz

■ Coil Characteristics

• AC operation

Frame size	Power consumption (VA)		Power loss (W)		Pick-up voltage (V) *1	Drop-out voltage (V) *1	Operating time (ms)	
	Inrush 50/60 Hz	Sealed 50/60 Hz	50Hz	60Hz			Coil ON → Contact ON	Coil OFF → Contact OFF
E02 to E05	90/95	9/9	2.7	2.8	0.85–1.1 X US	0.2–0.75 X US	9–20	5–16
E1 to E2S	120/135	12.7/12.4	3.6	3.8	0.85–1.1 X US	0.2–0.75 X US	10–17	6–13
E3, E4	180/190	13.3/13.4	4.5	5	0.85–1.1 X US	0.2–0.75 X US	10–18	8–18
E5	80/95	4/4.6	3.2	3.6	0.85–1.1 X US	0.2–0.75 X US	39–45	27–33
E6, E7	190/230	4.9/5.8	3.4	3.7	0.8–1.1 X US	0.1–0.65 X US	31–37	30–36

Note: *1 US: Rated coil voltage

• DC operation

Frame size	Power consumption (VA)		Time constant (ms)	Pick-up voltage (V) *1	Drop-out voltage (V) *1	Operating time (ms)	
	Inrush	Sealed				Coil ON → Contact ON	Coil OFF → Contact OFF
E02/G to E05/G	7	7	50	0.85–1.1 X US	0.1–0.75 X US	45–49	10–26
E1/G to E2S/G	9	9	60	0.85–1.1 X US	0.1–0.75 X US	40–50	8–17
E3/G, E4/G	12	12	70	0.85–1.1 X US	0.1–0.75 X US	60–70	14–21
E5	20	2.8	1	0.85–1.1 X US	0.1–0.75 X US	35–41	26–32
E6, E7	225	3.2	1	0.8–1.1 X US	0.1–0.65 X US	28–34	27–33

Note: *1 US: Rated coil voltage

■ Auxiliary Contact Ratings for UL and CSA

Frame size	Rated insulation voltage (V)	Rated thermal current (A)	Making and breaking current (A)					
			AC (rating code A600)			DC (rating code Q300)		
			Voltage	Making	Breaking	Voltage	Making	Breaking
E02 to E4, E02/G to E4/G	–	–	–	–	–	–	–	–
E5 to E7	600	10	120V	60	6	125	0.55	0.55
			240V	30	3	250V	0.27	0.27
			480V	15	1.5			
			600V	12	1.2			

Contactors SC-E series

Ordering information and Characteristics

MSA CONTROL - (11) 3961-1171 - comercial@msacontrol.com.br

Ordering information

Specify the following :

1. Part number
2. Operating coil voltage code

SC-E 02 / G - 24VDC

Product category

Frame size

Operating coil voltage code
(see page 34)

AC coil operating: None
DC coil operating: /G

SC-E 5 - 24V

Product category

Frame size

Operating coil voltage code
(see page 34)

Electrical durability

AC-1 duty / SC-E02 to SC-E7

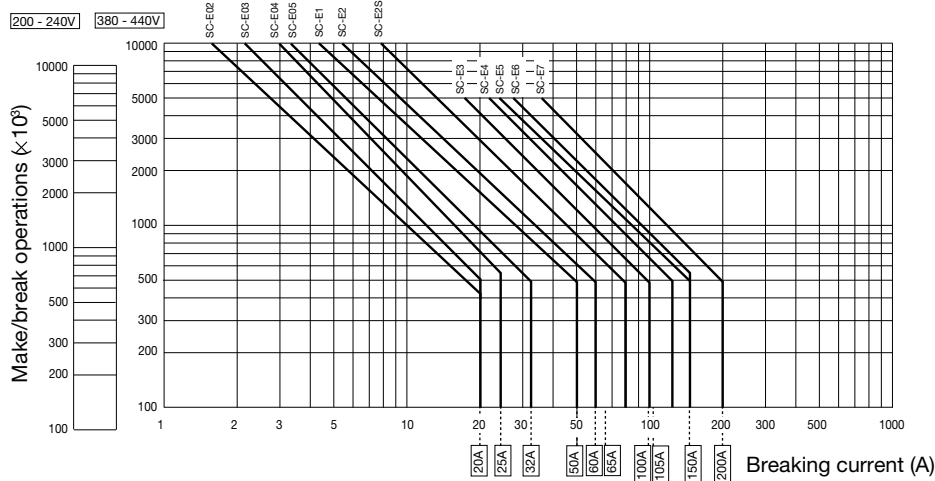

AC-3 duty / SC-E02 to SC-E6

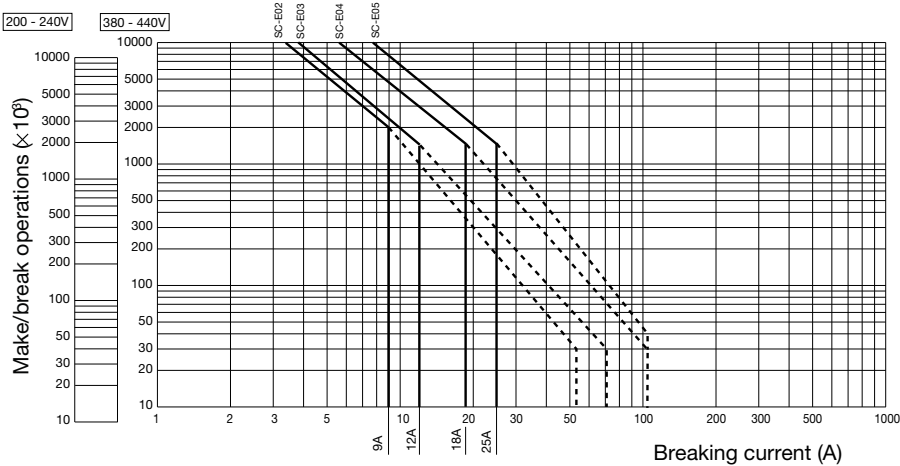

AC-3 duty / SC-E1 to SC-E7

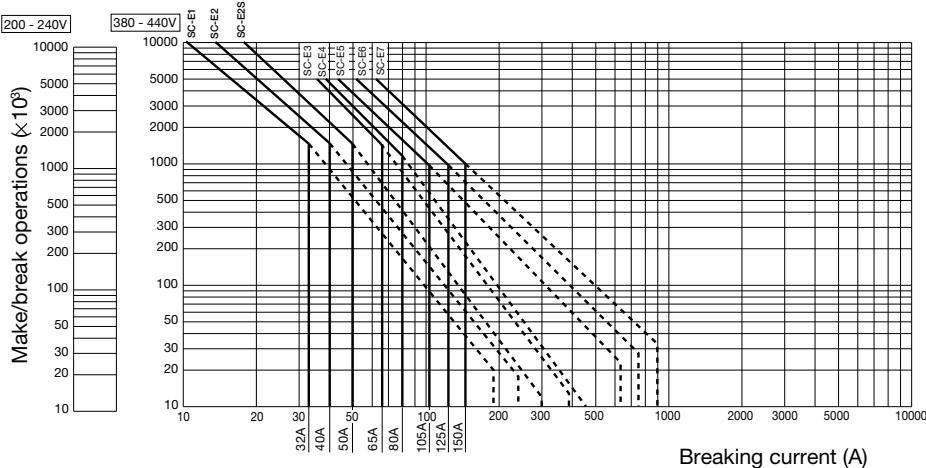

Contactor SC-E series

Optional Accessories

MSA CONTROL - (11) 3961-1171 - comercial@msacontrol.com.br

• Auxiliary Contact Blocks with Terminal Covers

Applicable contactor	Mounting	No. of contacts	Contact arrangement	Part number
SC-E02 to E4 SC-E02/G to E4/G	Front mounting	4	4NO	SZ-A40/T
			3NO+1NC	SZ-A31/T
			2NO+2NC	SZ-A22/T
		2	2NO	SZ-A20/T
			1NO+1NC	SZ-A11/T
			2NC	SZ-A02/T
	Side mounting	2	1NO+1NC	SZ-AS1/T
SC-E5, E6, E7	Side mounting	2	1NO+1NC	SZ-AS2/T

Contact Ratings

• Based on UL and CSA

Rated thermal current (A)	Making and breaking current (A)					
	AC (rating code A600)			DC (rating code Q300)		
	Volts	Making	Breaking	Volts	Making	Breaking
10	120V	60	6	125V	0.55	0.55
	240V	30	3	250V	0.27	0.27
	480V	15	1.5			
	600V	12	1.2			

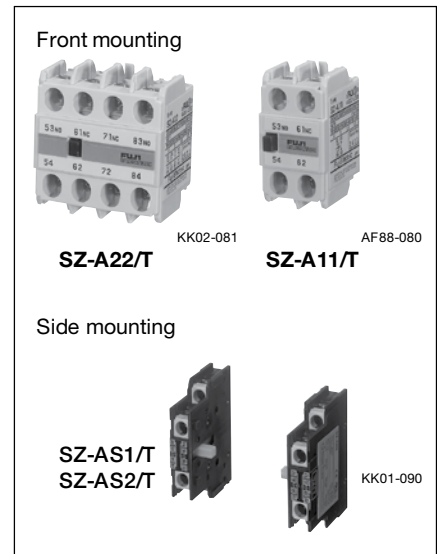

• Main Circuit Surge Suppression Units

Applicable contactor	Mounting	Rated voltage and frequency	CR constant	Applicable 3-phase motor	Part number
SC-E02 to E05 SC-E02/G to E05/G	Front mounting	250V AC	C=0.22 μF	200–240V AC	SZ-ZM1E
	Side mounting	50/60Hz	R=100 Ω	1-1/2–5HP	SZ-ZM2E
SC-E1 to E4 SC-E1/G to E4/G	Front mounting	250V AC	C=0.33 μF	200–240V AC	SZ-ZM3E
	Side mounting	50/60Hz	R=47 Ω	1-1/2–30HP	SZ-ZM4E

• Coil Surge Suppression Units

Applicable contactor	Operating coil voltage	Device	Operation indicator	Part number
SC-E02 to E05	SC-E02/G to E05/G	24–48V AC/DC	–	SZ-Z1
		100–250V AC/DC	–	SZ-Z2
		380–440V AC/DC	–	SZ-Z3
SC-E02 to E05	SC-E02/G to E05/G	24–48V AC/DC	Red LED	SZ-Z6
		100–250V AC/DC	Red LED	SZ-Z7
		–	–	–
SC-E1 to E4	SC-E1/G to E4/G	24–48V AC/DC	–	SZ-Z31
		100–250V AC/DC	–	SZ-Z32
		380–440V AC/DC	–	SZ-Z33
SC-E02 to E05	SC-E02/G to E05/G	24–48V AC/DC	–	SZ-Z4
		100–250V AC/DC	–	SZ-Z5
SC-E02 to E05	SC-E02/G to E05/G	24–48V AC/DC	Red LED	SZ-Z8
		100–250V AC/DC	Red LED	SZ-Z9
SC-E1 to E4	–	24–48V AC/DC	–	SZ-Z34
		100–250V AC/DC	–	SZ-Z35
		–	–	–
–	SC-E1/G to E4/G	24–48V AC/DC	–	SZ-Z36
		100–250V AC/DC	–	SZ-Z37

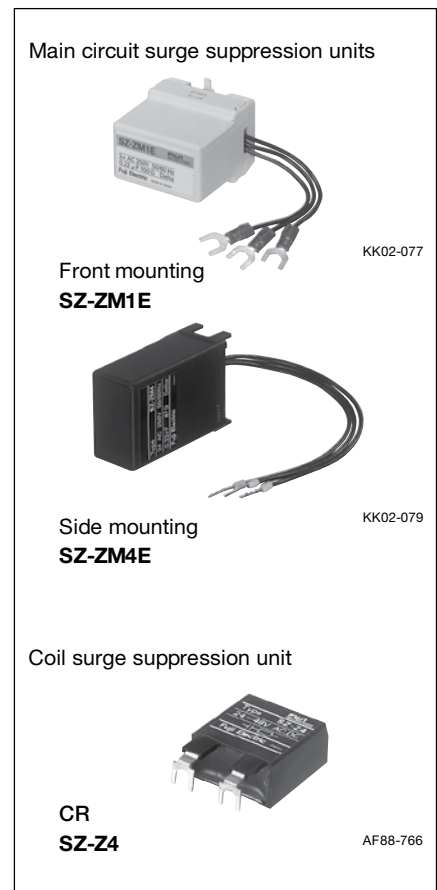

Contactors SC-E series

Optional Accessories

MSA CONTROL - (11) 3961-1171 - comercial@msacontrol.com.br

• Power Connection Kit for Reversing for SC-E Contactor

Description	Applicable contactor	Part number	Mass (g)
Line side wire kit	SC-E02 to E05	SZ-ERW1/A	19
Load side wire kit	SC-E02/G to E05/G	SZ-ERW1/B	17
Load side wire kit for the contactor to be connected with overload relay.		SZ-ERW1/D	13
Line side wire kit	SC-E1 to E2S,	SZ-ERW2/A	48
Load side wire kit	SC-E1/G to E2S/G,	SZ-ERW2/B	42
Load side wire kit for the contactor to be connected with overload relay.		SZ-ERW2/D	31
Line side wire kit	SC-E3,E4	SZ-ERW3/A	162
Load side wire kit	SC-E3/G,E4/G	SZ-ERW3/B	138
Load side wire kit for the contactor to be connected with overload relay.		SZ-ERW3/D	110

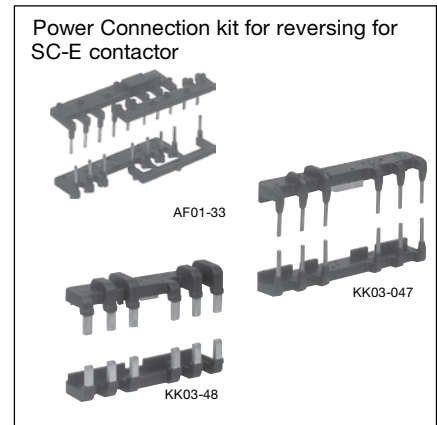

• Mechanical Interlock Unit

Description	Applicable contactor	Part number	Mass (g)
	SC-E02 to E4	SZ-RM	27
	SC-E02/G to E4/G		



• Preparing to Make Reversing Contactors and Motor Starters

<For SC-E contactor>

1. SC-E_ x 2
2. SZ-ERW_/A x 1
3. SZ-ERW_/B x 1
4. SZ-RM x 1
5. SZ-_A/T x 2

<For SC-E motor starters>

1. SC-E_ x 2
2. TK-E_ X1
3. SZ-ERW_/A x 1
4. SZ-ERW_/D x 1
5. SZ-RM x 1
6. SZ-_A/T x 2

Example of connecting, SC-E reversing motor starter

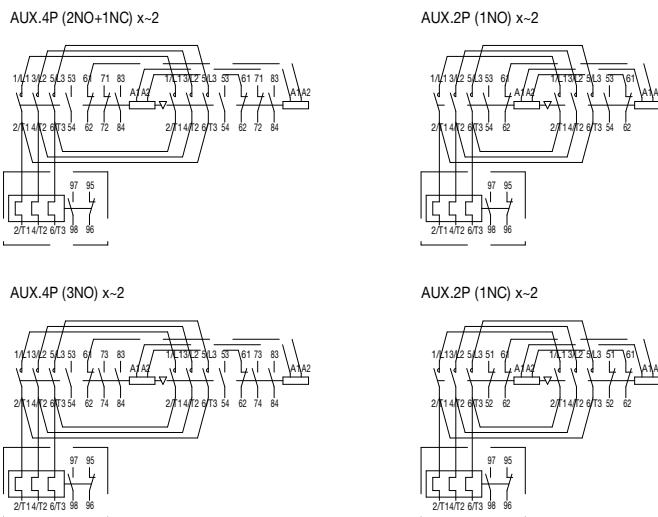

Contactors SC-E series

Optional Accessories

MSA CONTROL - (11) 3961-1171 - comercial@msacontrol.com.br

■ Replacement Coils

Replacement coil for SC-E series, AC coil is available, DC coil is not available

Contactora part number	AC coil part number	Super magnet coil part number
SC-E02 to E05	4NC0H-#MC	N/A

Replace the # symbol with the desired code, shown in the chart below.

Code letter #	AC coil 60Hz	AC coil 50Hz
E	24-26V	24V
F	48-52V	48V
A	100-110V	100V
1	110-120V	100-110V
G	120-130V	110-120V
B	200-220V	200V
2	220-240V	200-220V
C	400-440V	380-400V
4	440-480V	415-440V
5	550-600	500-550V

Contactora part number	AC coil part number (Chart 1)	Super magnet coil part number (Chart 2)
SC-E1, E2 and E2S	SZ-GM/N1-#	N/A
SC-E3 and E4	SZ-GM/N2S-#	N/A
SC-E5	N/A	SZ-GS/N5-#
SC-E6 and E7	N/A	SZ-GS/N6-#

Replace the # symbol with the desired code, shown in the charts below.

Chart 1 : AC coil

Code letter #	AC coil 60Hz	AC coil 50Hz
24	24-26V	24V
48	48-52V	48V
100	100-110V	100V
110	110-120V	100-110V
120	120-130V	110-120V
200	200-220V	200V
220	220-240V	200-220V
400	400-440V	380-400V
440	440-480V	415-440V
500	500-550V	480-500V

Chart 2 : Super magnet coil

Code letter #	AC coil 50/60Hz	DC
24	24-25V	24V
48	48-50V	48V
100	100-127V	100-120V
200	200-250V	200-240V
400	380-450V	N/A
500	460-575V	N/A

Contactors SC-E series

Dimensions

MSA CONTROL - (11) 3961-1171 - comercial@msacontrol.com.br

■ Dimensions, mm

• Non-reversing AC operated
SC-E02, E03, E04, E05

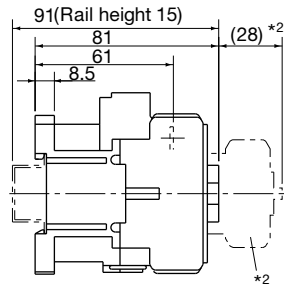

Mass: 0.33kg

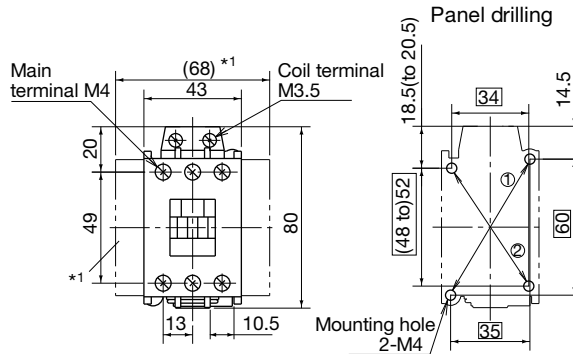

■ Wiring diagrams

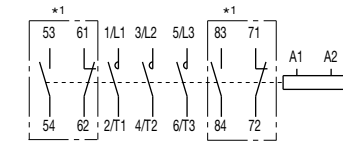

*1 In case of aux. contact 2NO+2NC

Use the two mounting holes on a diagonal line
① or ② to mount contactor
①: 35 × 60 ②: 35 × (48 to) 52

SC-E1, E2, E2S

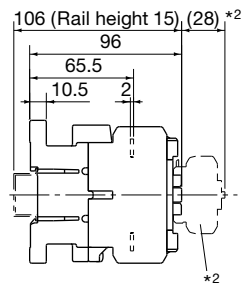

Mass : 0.58kg

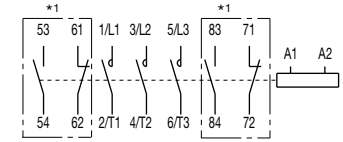
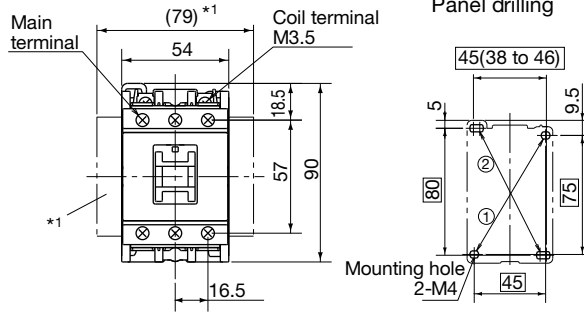

*1 In case of aux. contact 2NO+2NC

Use the two mounting holes on a diagonal line
① or ② to mount contactor
①: 45 × 75 ②: 45 (38 to 46) × 80

SC-E3, E4

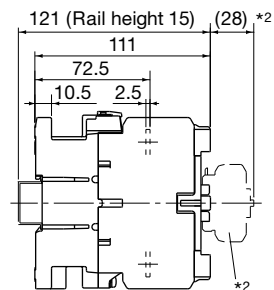

Mass: 1.1kg

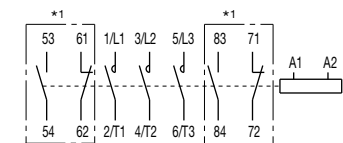
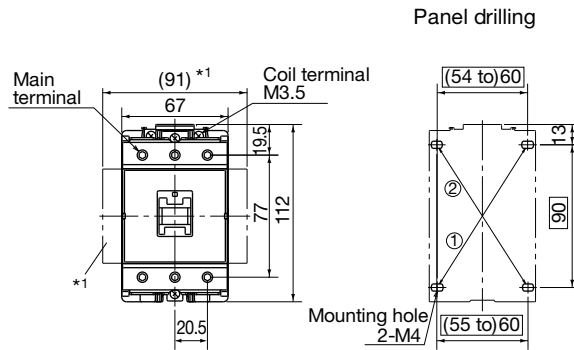

*1 In case of aux. contact 2NO+2NC

Use the two mounting holes on a diagonal line
① or ② to mount contactor
①: (55 to) 60 × 90 ②: (54 to) 60 × 90

SC-E5

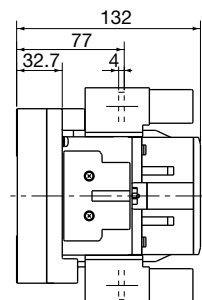

Mass: 2.0kg

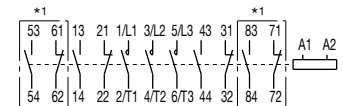
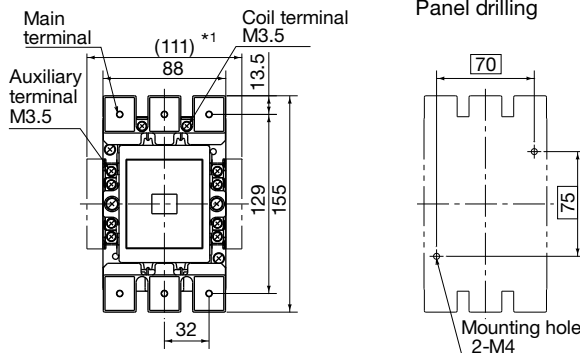

*1 In case of aux. contact 4NO+4NC

*1 Side mounting aux. contact block
*2 Front mounting aux. contact block

Contactors SC-E series Dimensions

MSA CONTROL - (11) 3961-1171 - comercial@msacontrol.com.br

■ Dimensions, mm

• Non-reversing AC operated

SC-E6

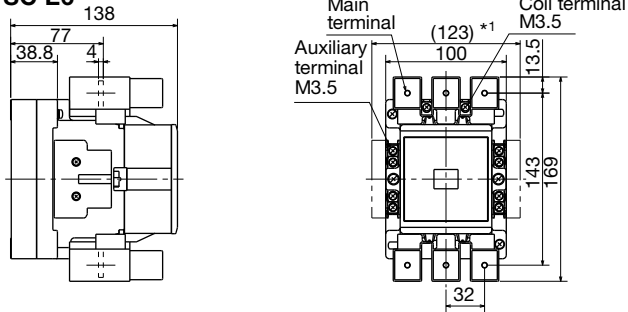

Mass: 2.6kg

SC-E7

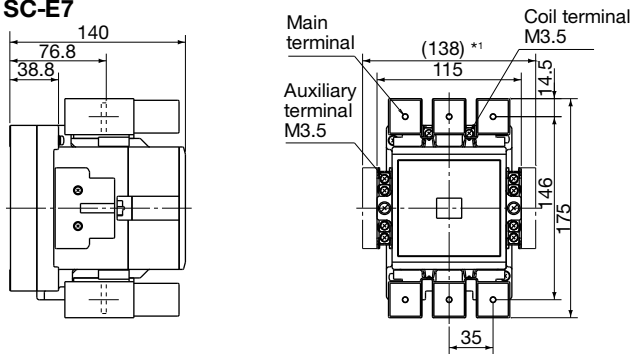

Mass: 2.9kg

• Non-reversing DC operated

SC-E02/G, E03/G, E04/G, E05/G

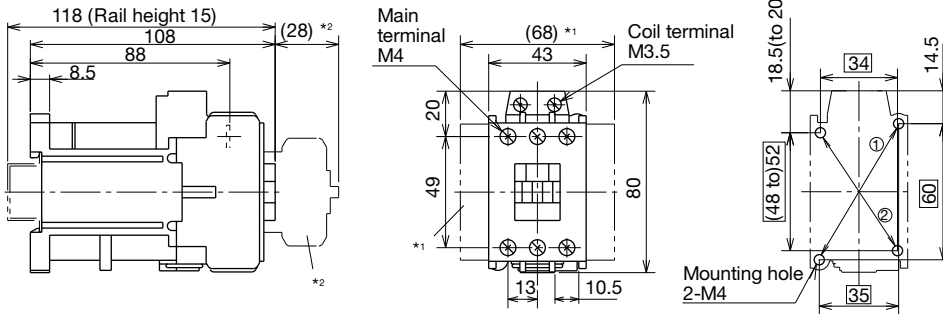

Mass: 0.59kg

SC-E1/G, E2/G, E2S/G

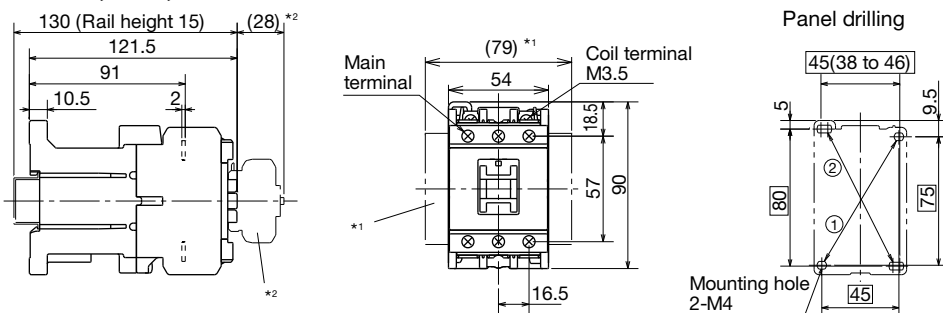

Mass: 0.79kg

*1 Side mounting aux. contact block
*2 Front mounting aux. contact block

■ Wiring diagrams

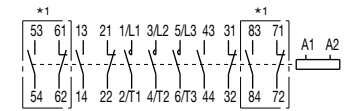

*1 In case of aux. contact 4NO+4NC

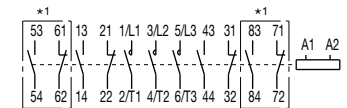

*1 In case of aux. contact 4NO+4NC

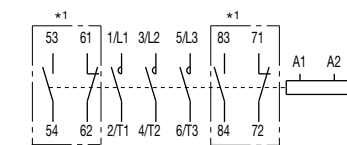

*1 In case of aux. contact 2NO+2NC

Use the two mounting holes on a diagonal line
① or ② to mount contactor
①: 35 × 60 ②: 35 × (48 to 52)

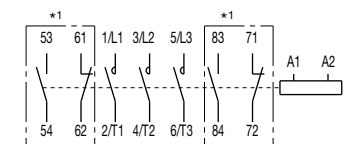

*1 In case of aux. contact 2NO+2NC

Use the two mounting holes on a diagonal line
① or ② to mount contactor
①: 45 × 75 ②: 45 (38 to 46) × 80

Contactors SC-E series

Dimensions

MSA CONTROL - (11) 3961-1171 - comercial@msacontrol.com.br

■ Dimensions, mm

- Non-reversing DC operated
- SC-E3/G, E4/G

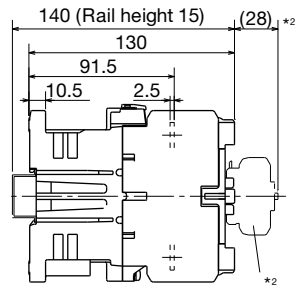

Mass: 1.4kg

*1 Side mounting aux. contact block
*2 Front mounting aux. contact block

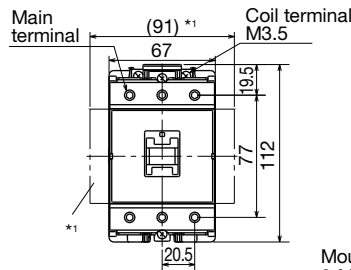

Panel drilling

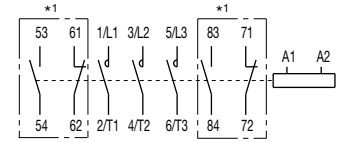
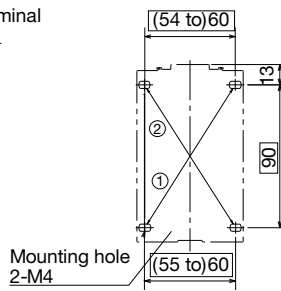

*1 In case of aux. contact 2NO+2NC

Use the two mounting holes on a diagonal line

① or ② to mount contactor
①: (55 to) 60 × 90 ②: (54 to) 60 × 90

- Auxiliary contact blocks Front mounting
- SZ-A40/T, A31/T, A22/T, A20/T, A11/T, A02/T for SC-E02 to E4

Contactor with aux. contact block

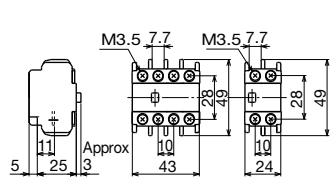

SZ-A40/T, A31/T, A22/T Mass: 36g
SZ-A20/T, A11/T, A02/T Mass: 20g

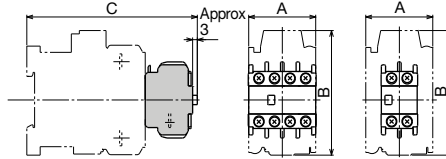

Type	A	B	C
SC-E02, E03, E04, E05	43	80	109
SC-E1, E2, E2S	54	90	124
SC-E3, E4	67	112	139

■ Wiring diagrams

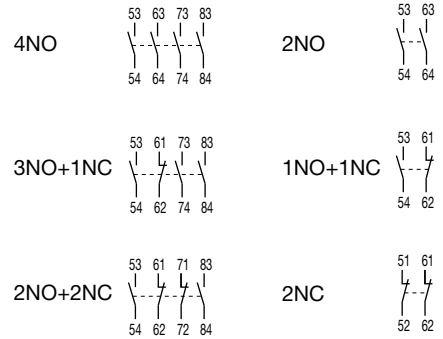

- Auxiliary contact blocks Side mounting
- SZ-AS1/T, for SC-E02 to E4

Contactor with aux. contact block

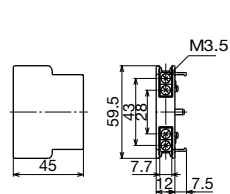

Mass: 28g

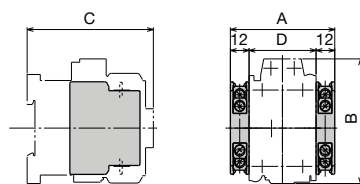

Type	A	B	C	D
SC-E02, E03, E04, E05	67	80	81	43
SC-E1, E2, E2S	78	90	96	54
SC-E3, E4	91	112	111	67

1NO+1NC Mounted on right side



Mounted on left side



- SZ-AS2/T, for SC-E5 to E7

Contactor with aux. contact block

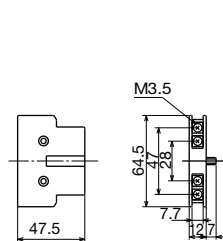

Mass: 40g

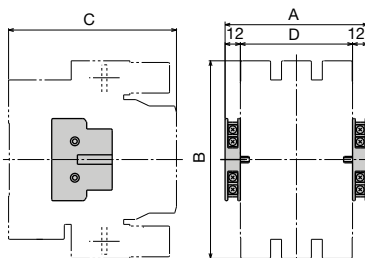

Type	A	B	C	D
SC-E5	112	155	132	88
SC-E6	124	169	138	100
SC-E7	139	175	140	115

1NO+1NC Mounted on right side



Mounted on left side



Contactors SC-E series Dimensions

MSA CONTROL - (11) 3961-1171 - comercial@msacontrol.com.br

■ Dimensions, mm

• Main circuit surge suppression units

SZ-ZM1E

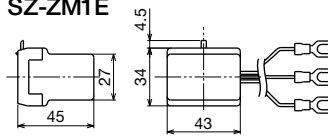

SZ-ZM3E

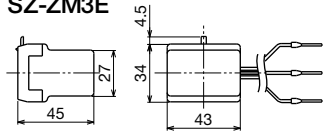

Mass: 60g

Contactor with surge suppression unit

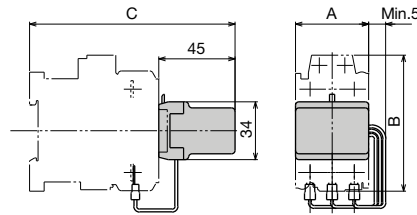

Type	A	B	C
SC-E02+SZ-ZM1E	43	80	121
SC-E03			
SC-E04			
SC-E05			
SC-E1+SZ-ZM3E	54	90	136
SC-E2			
SC-E2S			
SC-E3+SZ-ZM3E	67	112	151
SC-E4			

SZ-ZM2E

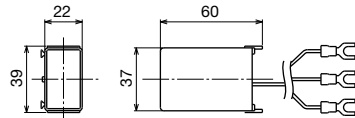

SZ-ZM4E

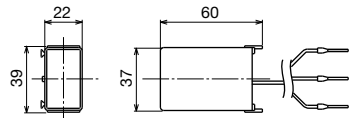

Mass: 60g

Contactor with surge suppression unit

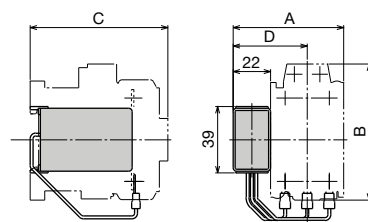

Type	A	B	C	D
SC-E02+SZ-ZM2E	65	80	81	43.5
SC-E03				
SC-E04				
SC-E05				
SC-E1				
SC-E2+SZ-ZM2E	76	90	96	49
SC-E2S				
SC-E3+SZ-ZM2E	89	112	111	55.5
SC-E4				

Connection diagram

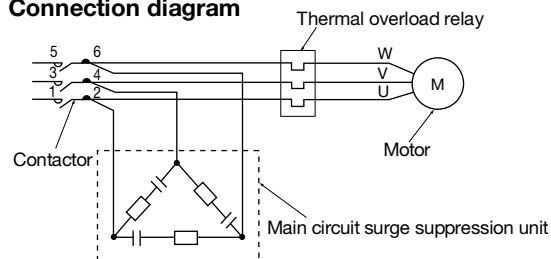

• Coil surge suppression units

SZ-Z1, Z2, Z3, Z4, Z5

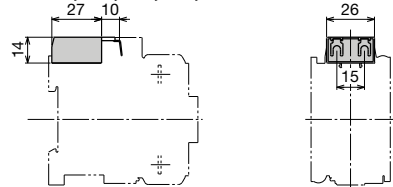

Mass: 14g

SZ-Z6, Z7, Z8, Z9

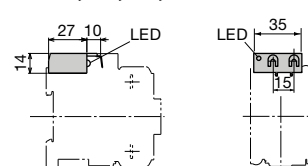

Mass: 16g

SZ-Z31, Z32, Z33, Z34, Z35, Z36, Z37

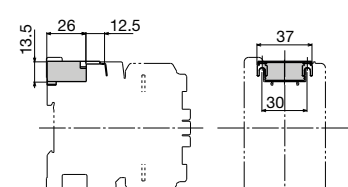

Mass: 15g

SC-E02 to E05 + SZ-Z1 to Z3
(Built-in varistor)

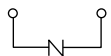

SC-E02 to E05 + SZ-Z6, Z7
(Built-in varistor with operating indicator)

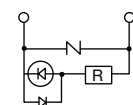

SC-E1 to E4 + SZ-Z31 to Z33
(Built-in varistor)

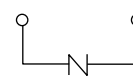

SC-E02 to E05 + SZ-Z4, Z5
(Built-in CR)



SC-E02 to E05 + SZ-Z8, Z9
(Built-in CR with operating indicator)

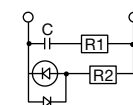

SC-E1 to E4 + SZ-Z34, Z35
(Built-in CR)
SC-E1/G to E4/G + SZ-Z36, Z37
(Built-in CR)

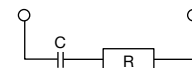

Contactors SC-E series

Dimensions

MSA CONTROL - (11) 3961-1171 - comercial@msacontrol.com.br

■ Dimensions, mm

- Power connection kit for reversing for SC-E

SZ-ERW1/A

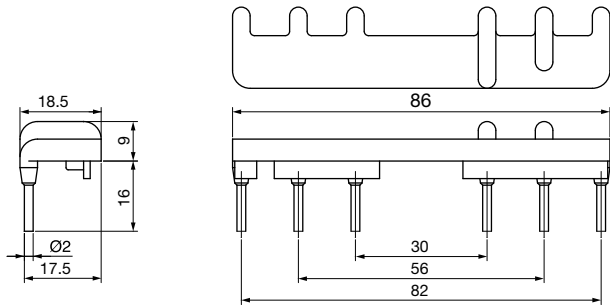

SZ-ERW1/B

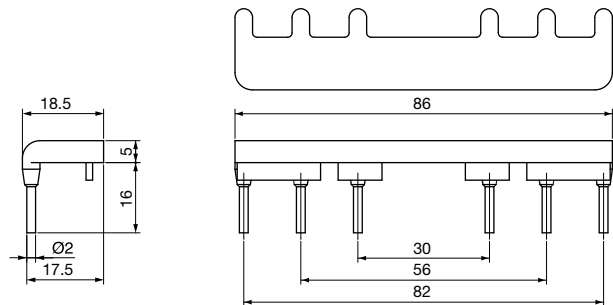

SZ-ERW1/D

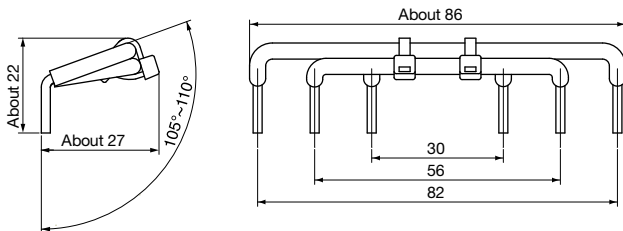

SZ-ERW2/A

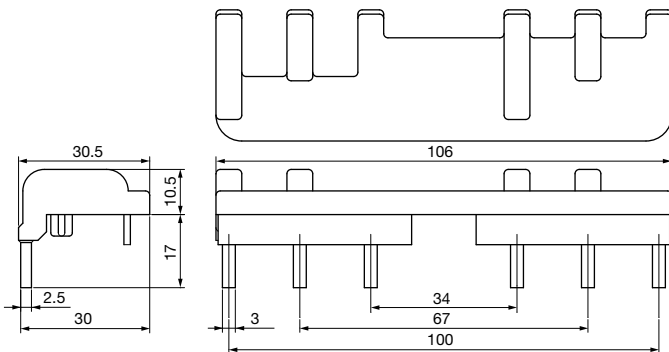

SZ-ERW2/B

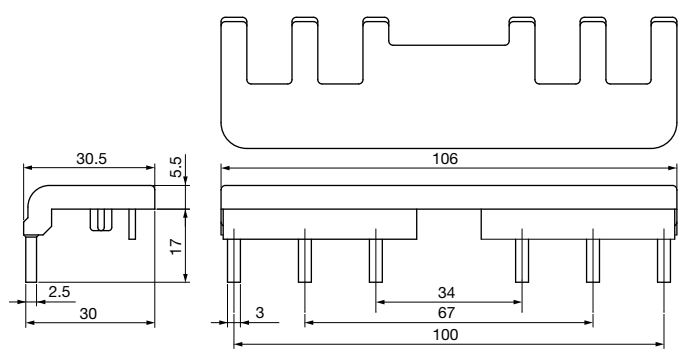

SZ-ERW2/D

6/T3 - 2/T1	<p>Side view: 'About 31' mm width, 1 mm offset, 'About 18.5' mm height. Front view: 8 mm terminal offset, 26 mm terminal spacing.</p>
4/T2 - 4/T2	<p>Side view: 'About 31' mm width, 1 mm offset, 'About 22' mm height. Front view: 8 mm terminal offset, 59 mm terminal spacing.</p>
2/T1 - 6/T3	<p>Side view: 'About 42' mm width, 1 mm offset, 'About 22' mm height. Front view: 8 mm terminal offset, 92 mm terminal spacing.</p>

Contactors SC-E series Dimensions

MSA CONTROL - (11) 3961-1171 - comercial@msacontrol.com.br

■ Dimensions, mm

Power connection kit for reversing for SC-E

SZ-ERW3/A

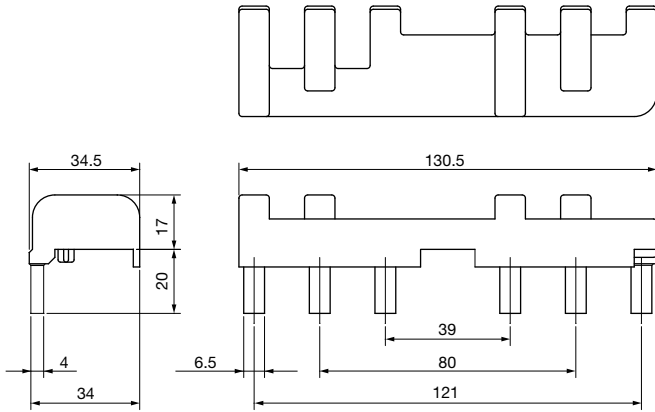

SZ-ERW3/B

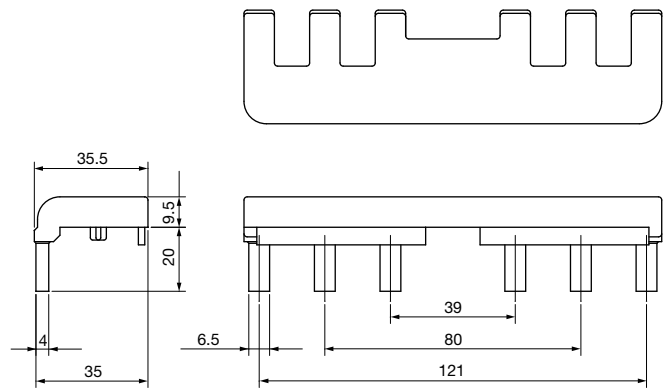

SZ-ERW3/D

6/T3 - 2/T1	<p>Dimensions for 6/T3 - 2/T1: Terminal height About 25.5 mm, distance from bottom edge to terminal base 2.5 mm, distance from bottom edge to terminal base About 22.5 mm, terminal width 10 mm, distance between terminals 29 mm.</p>
4/T2 - 4/T2	<p>Dimensions for 4/T2 - 4/T2: Terminal height About 25.5 mm, distance from bottom edge to terminal base 2.5 mm, distance from bottom edge to terminal base About 28 mm, terminal width 10 mm, distance between terminals 70 mm.</p>
2/T1 - 6/T3	<p>Dimensions for 2/T1 - 6/T3: Terminal height About 38.5 mm, distance from bottom edge to terminal base 2.5 mm, distance from bottom edge to terminal base About 28 mm, terminal width 10 mm, distance between terminals 111 mm.</p>

Contactors SC-E series

Instructions

MSA CONTROL - (11) 3961-1171 - comercial@msacontrol.com.br

Standard operating conditions

The magnetic contactors are manufactured for use in the standard operating conditions given in the table at the right. Consult Fuji Electric before using the magnetic contactors in different conditions.

Wirings

• Connection wires and terminal processing

Be sure to perform wiring correctly with reference to the connections diagram. Main terminals for models SC-E02 to SC-E7 are wired using solid wires or stranded wires.

Stranded wires or flexible stranded wires can be connected by twisting them together, crimping a sleeve (ferrule) onto them before connecting.

• Tightening torque

If wires are not tightened sufficiently, they may become hot or come loose and result in a fire, short-circuit, electric shock, or some other potentially dangerous situation. Be sure to tighten the wires to the torques specified in the tables below.

• Connectable wire sizes, tightening tools, tightening torques



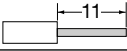

Main circuit

Contactor type		SC-E02 SC-E02/G	SC-E03 SC-E03/G	SC-E04 SC-E04/G	SC-E05 SC-E05/G
Solid wire (mm ²)	One	0.75 to 4		0.75 to 6	
	Two	1 to 4		1.5 to 6	
Stranded wire (mm ²)	One	0.75 to 4		0.75 to 6	
	Two	1 to 4		1.5 to 6	
AWG	One	12 max.		10 max.	
	Two	12 max.		10 max.	
Sheath stripping length (mm)					
Terminal screw size		M4			
Tool		⊕ Phillips screwdriver, H-type, No. 2 (ISO 8764) ⊖ Flat-blade screwdriver, 1×5.5×L-type, B (ISO 2830)			
Tightening torque (N·m)		1.2 to 1.5			

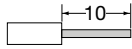
Ambient temperature	Operating: -5 to 55°C No sudden temperature changes resulting in condensation or icing (The average temperature over a 24-hour period must not exceed 35°C) Storage: -40 to 65°C
Humidity	45 to 85%RH
Altitude	2000m or lower
Atmosphere	No excessive dust, smoke, corrosive gases, flammable gases, steam, or salt
Vibration	10 to 55Hz 15m/s ²
Shock	50m/s ²
Mounting	Screw mounting, 35mm DIN rail mounting (SC-E02 to SC-E4)
Mounting angle	
Standard	IEC 60947-4-1, EN 60947-4-1, VDE 0660 JIS C 8201-4-1, JEM 1038 UL 508, CSA C22.2

Control circuit

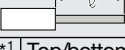
Solid or stranded wire (mm ²)	One	0.75 to 2.5 (ø1 to 1.6)
	Two	0.75 to 2.5
AWG	One	18 to 14
	Two	18 to 14
Sheath stripping length (mm)		
Fork terminal		Max. 7.7mm wide
Terminal screw size		M3.5
Tool		⊕ Phillips screwdriver, H-type, No. 2 (ISO 8764) ⊖ Flat-blade screwdriver, 1×5.5×L-type, B (ISO 2830)
Tightening torque (N·m)		0.8 to 1

Contactor type		SC-E1, E2, E2S SC-E1/G, E2/G, E2S/G	SC-E3, E4 SC-E3/G, E4/G	SC-E5, E6	SC-E7	
Top-only connection 	Solid or stranded wire (mm ²) *1	0.75 to 35	1.5 to 70	4 to 70	4 to 120	
	Flexible stranded wire with sleeve (mm ²) *1	0.75 to 25	1.5 to 50	2.5 to 50	2.5 to 95	
	Flexible stranded wire without sleeve (mm ²) *1	0.75 to 25	1.5 to 50	4 to 50	4 to 95	
	AWG	18 to 2	16 to 2/0	12 to 2/0	12 to 250MCM	
	Solid or stripping length (mm)		15	19.5	26.5	28.5
Bottom-only connection 	Single stranded wire (mm ²) *1	0.75 to 25	1.5 to 50	4 to 70	4 to 120	
	Flexible stranded wire with sleeve (mm ²) *1	0.75 to 16	1.5 to 35	2.5 to 50	2.5 to 95	
	Flexible stranded wire without sleeve (mm ²) *1	0.75 to 16	1.5 to 35	4 to 50	4 to 95	
	AWG	18 to 3	16 to 1/0	12 to 2/0	12 to 250MCM	
	Sheath stripping length (mm)		12.5	16	26.5	28.5
Top/bottom connection 	Solid or stranded wire (mm ²) *1	Top/bottom	1.5 to 50	4 to 70	4 to 120	
	Flexible stranded wire with sleeve (mm ²) *1	Top/bottom	1.5 to 35	2.5 to 50	2.5 to 95	
	Flexible stranded wire without sleeve (mm ²) *1	Top/bottom	0.75 to 16	1.5 to 35	4 to 50	4 to 95
	AWG	Top/bottom	18 to 3	16 to 1/0	12 to 2/0	12 to 250MCM
	Tool		⊕ Phillips screwdriver, H-type, No. 2 (ISO 8764) ⊖ Flat-blade screwdriver, 1×5.5×L-type, B (ISO 2830)	⊙ Hex. wrench 4 (ISO 2936)		
Tightening torque (N·m)		2.5	8	10		
Self-locking torque (N·m) *2		1	2			

Notes: *1 Stranded wire (0 to 25mm²) consists of 7 wires or less.
Stranded wire (35 to 120mm²) consists of 19 wires or less.
Flexible stranded wire consists of more number wires than the above.

*2 The tightening bolt must be loosened in order to insert the wire. However, stop loosening the bolt when the anti-drop attachment on the bottom of the bolt reaches the top edge of the terminal. If a torque exceeding that given in the table is applied in this state, the retaining bracket may come loose.

Thermal Overload Relays TK-E series

Quick Reference Guide and Ordering Information

MSA CONTROL - (11) 3961-1171 - comercial@msacontrol.com.br

TK-E series with Open-phase Protection Device

■ Features

- This relay protects motor windings from burning due to overloads, locked rotor current, or open-phases.
- Maintenance and inspection safety has been improved by employing a finger protection mechanism to cover exposed terminals (conforms to DIN 57106, VDE 0106 Teil 100).
- A high-precision scale for the current adjustment dial enables easy and exact current setting.
- The operating status can be visually checked with ease.
- The relays can be manually tripped. A trip-free mechanism is also provided.
- Base unit can be added to enable separate-mounting types of the TK26E, E2, and E3 models.

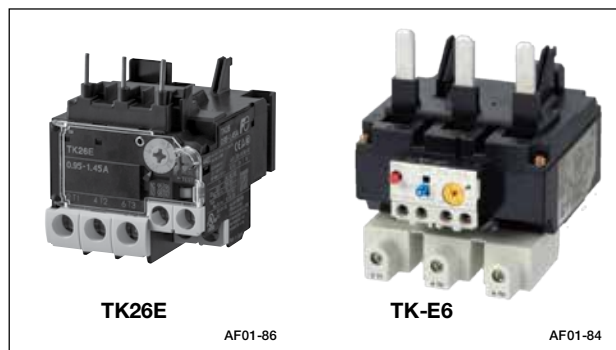

■ Part Number and Specification

Applicable contactor	Part number	Aux. contact	Trip category (JIS)	No. of heater elements	Power consumption per pole	Provided functions
SC-E02 to E05, E02/G to E05/G	TK26E	1NO+1NC	10A	3	1.7VA	Overload, phase-loss protection Ambient temperature compensation Manual or auto reset selectable Manual trip mechanism Trip indicator
SC-E1 to E2S, E1/G to E2S/G	TK-E2				3.8VA	
SC-E3, E4, E3/G, E4/G	TK-E3				6.6VA	
SC-E5	TK-E5				6.6VA	
SC-E6, E7	TK-E6				8.0VA	

Note: Separate mounting type is available for TK-E6. The part number is TK-E6H.

■ Ampere Ranges (Part Number Codes)

Thermal overload relay type				
TK26E	TK-E2	TK-E3	TK-E5	TK-E6, E6H *
0.1-0.15 (P10)				
0.13-0.2 (P13)				
0.18-0.27 (P18)				
0.24-0.36 (P24)				
0.34-0.52 (P34)				
0.48-0.72 (P48)				
0.64-0.96 (P64)				
0.8-1.2 (P80)				
0.95-1.45 (P95)				
1.1-1.65 (1P1)				
1.4-2.1 (1P4)				
1.7-2.6 (1P7)				
2.2-3.4 (2P2)				
2.8-4.2 (2P8)				
4-6 (004)	4-6			
5-7.5 (005)				
	5-8			
6-9 (006)	6-9			
7-10.5 (007)				
	7-11	7-11		
9-13 (009)	9-13	9-13		
12-18 (012)	12-18	12-18		
16-22 (016)				
	18-26	18-26	18-26	
20-26 (020)				
	24-36	24-36	24-36	
		28-40	28-40	
	32-42			
		34-50	34-50	
	40-50			
	44-54			
		45-65	45-65	45-65
		48-68		
				53-80
		64-80		
			65-95	65-95
			85-105	
				85-125
				110-160

■ Standards

IEC 60947-4-1, EN60947-4-1
VDE 0660, JIS C 8201-4-1
UL 508, CSA C22.2

■ Ordering Information

Specify the following:

1. Part number
2. Ampere range

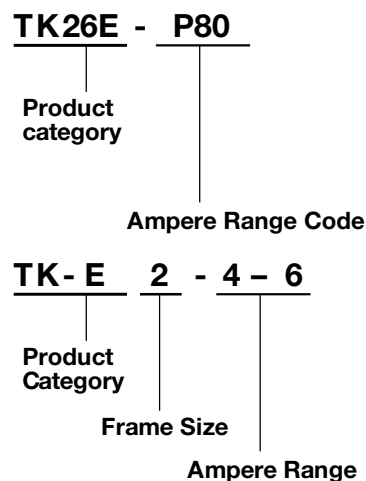

Note: * Applicable only for separate-mounting type. Not applicable for use in combination with a magnetic contactor

Thermal Overload Relays TK-E series

Characteristics

MSA CONTROL - (11) 3961-1171 - comercial@msacontrol.com.br

Auxiliary Contact Ratings

• Based on UL and CSA

Part number	Rated insulation voltage (V)	Rated thermal current (A)	Making and breaking current (A)					
			AC (rating code B600)			DC (rating code R300)		
			Voltage (V)	Making (A)	Breaking (A)	Voltage (V)	Making (A)	Breaking (A)
TK26E	600	5	120	30	3	120	0.22	0.22
TK-E2, E3			240	15	1.5	250	0.11	0.11
TK-E5			480	7.5	0.75			
TK-E6			600	6	0.6			

Operating Characteristics (mean value)

•TK26E

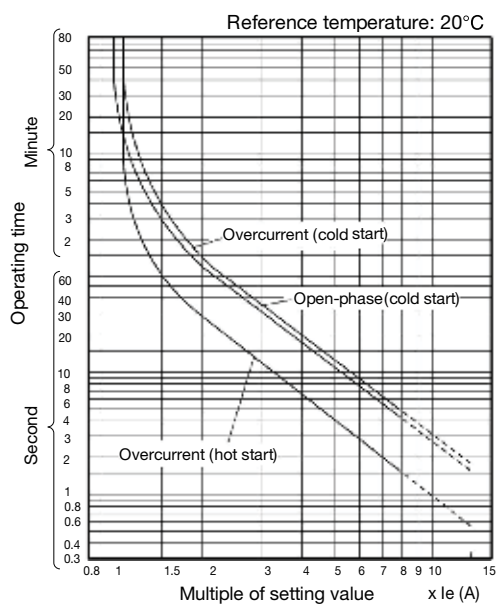

•TK-E2 to E6, E6H

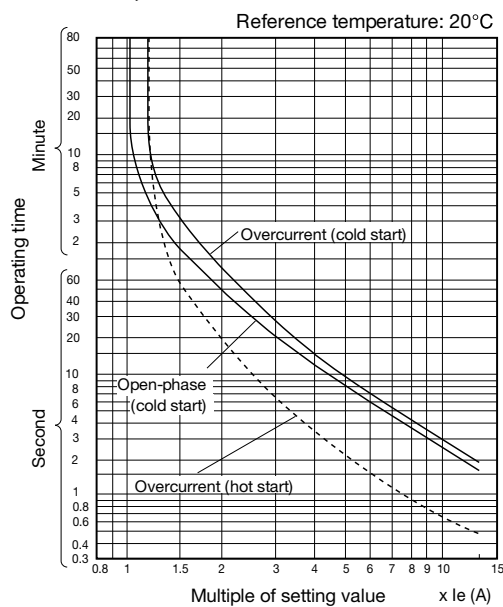

Thermal Overload Relays TK-E series

Optional Accessories

MSA CONTROL - (11) 3961-1171 - comercial@msacontrol.com.br

■ Optional Accessories for TK-E series

• Base Unit for Separate Mounting

The base unit modifies thermal overload relays to separate mounting that can be mounted to 35mm-wide IEC top hat rail or secured with screws.

Applicable thermal overload relay	Type
TK26E	TZ1H26E
TK-E2	SZ-HDE
TK-E3	SZ-HEE

• Trip Indicator

Reports any tripping action at a thermal overload relay through its LED display.

Applicable thermal overload relay	Rated voltage	Type
TK-E2 to TK-E6	100–110V AC, 50/60Hz	SZ-L100N2
	200–220V AC, 50/60Hz	SZ-L200N2

• Reset Release Button

Reset a thermal overload relay from the rear side of the board or a distant location.

Applicable thermal overload relay	Load length (mm)	Type
TK26E	300	SZ-R1
	500	SZ-R2
	700	SZ-R3
TK-E2 to TK-E6	300	SZ-R4
	500	SZ-R5
	700	SZ-R6

• Dial Cover

Protects the setting current value of a thermal overload relay from being changed unintentionally.

Applicable thermal overload relay	Type
TK-E02 to TK-E6	SZ-DA

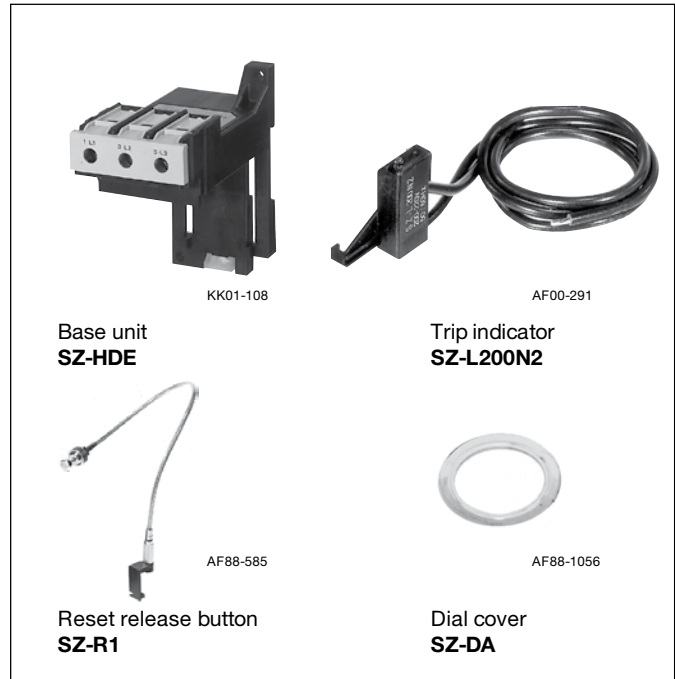

Thermal Overload Relays TK-E series

Dimensions

MSA CONTROL - (11) 3961-1171 - comercial@msacontrol.com.br

■ Dimensions, mm

TK26E

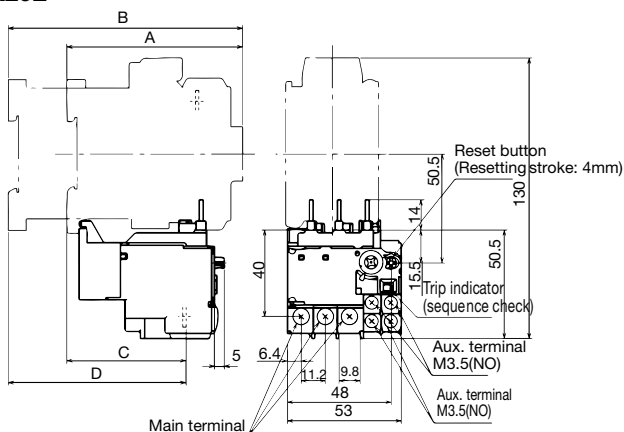

Contactor	A	B	C	D
SC-E02 to 05	81	-	55.5	-
SC-E02/G to 05/G	-	108	-	82.5

TK-E5 On-contactor mounting only

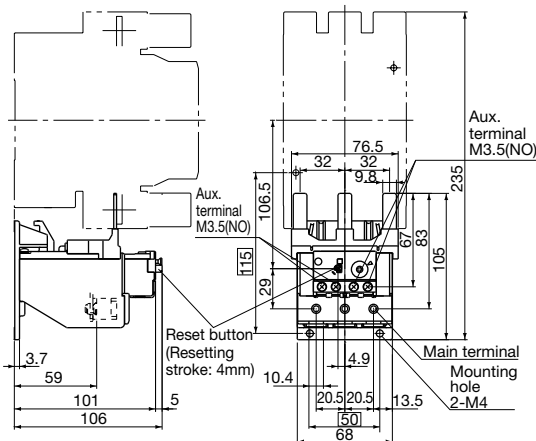

Mass: 0.37kg

TK-E2

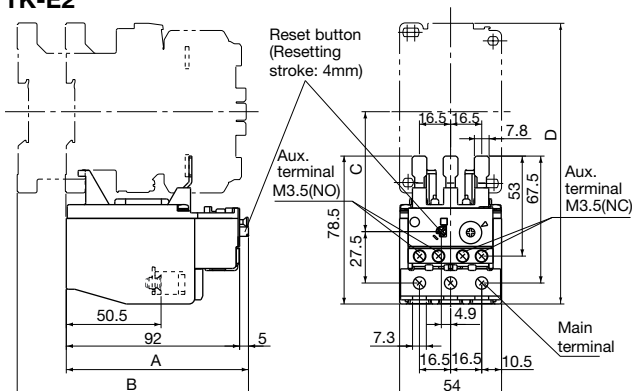

Contactor	A	B	C	D
SC-E1 to E2S	97	-	63.5	149
SC-E1/G to E2S/G	-	123	63.5	149

Mass: 0.25kg

TK-E6 On-contactor mounting only

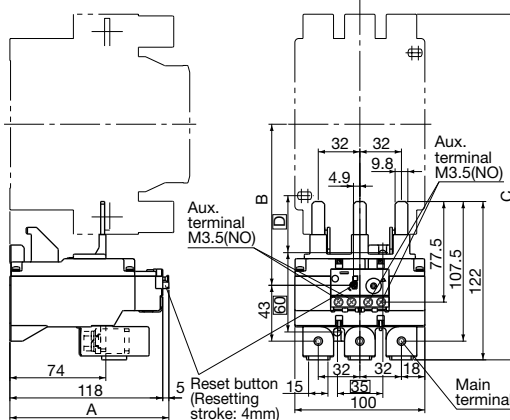

Contactor	A	B	C	D
SC-E6	123	124	266.5	45
SC-E7	123	129	274	50

Mass: 0.71kg

TK-E3

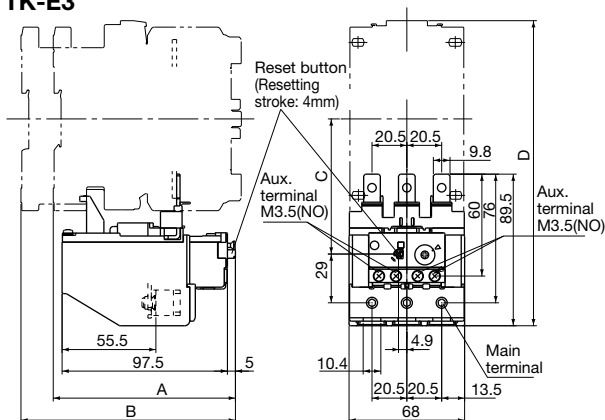

Contactor	A	B	C	D
SC-E3, E4	107.5	-	79.5	180
SC-E3/, E4/G	-	126.5	79.5	180

Mass: 0.34kg

TK-E6H For separate mounting only

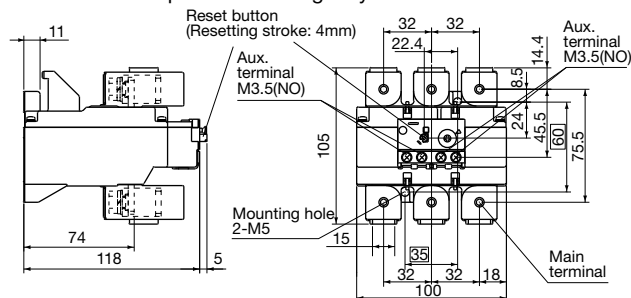

Mass: 0.82kg

■ Wiring Diagrams

3-heater element

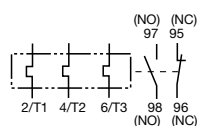

Thermal Overload Relays TK-E series Dimensions

MSA CONTROL - (11) 3961-1171 - comercial@msacontrol.com.br

■ Dimensions, mm

• Base Units for Separate Mounting TZ1H26E

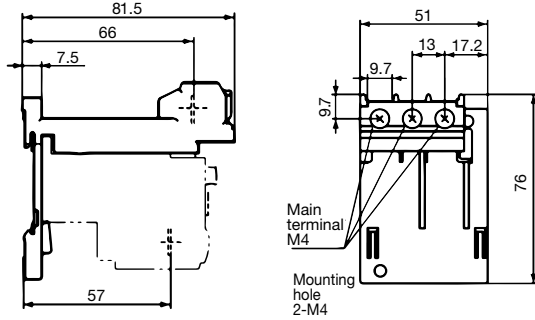

Mass: 0.04kg

• Trip Indicators SZ-L100N2, L200N2

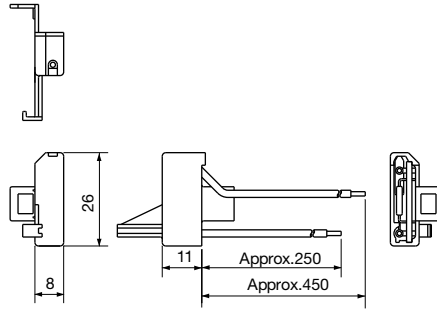

SZ-HDE

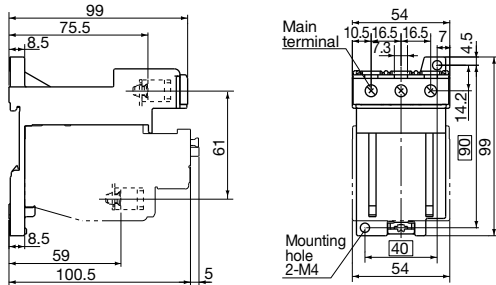

Mass: 0.1kg

• Reset Release Button SZ-R1, R2, R3

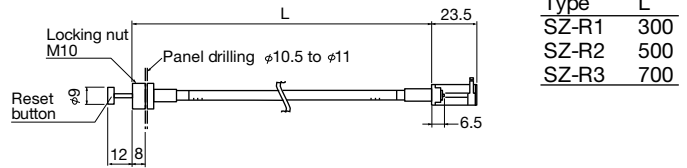

SZ-R4, R5, R6

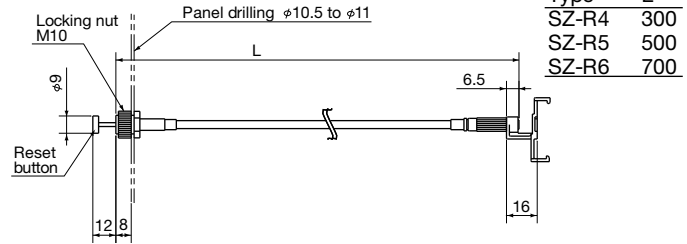

SZ-HEE

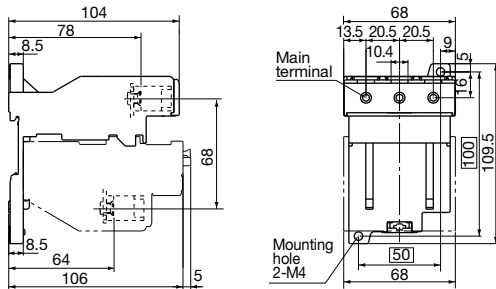

Mass: 0.15kg

• Dial Cover SZ-DA

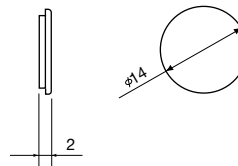

Thermal Overload Relays TK-E series

Instructions

MSA CONTROL - (11) 3961-1171 - comercial@msacontrol.com.br

■ Standard Operating Conditions

The thermal overload relays are manufactured for use in the standard operating conditions given in the table at the right. Consult Fuji Electric before using the thermal overload in different conditions.

Ambient temperature	Operating: -5 to 55°C No sudden temperature changes resulting in condensation or icing (The average temperature over a 24-hour period must not exceed 35°C) Storage: -40 to 65°C
Humidity	45 to 85%RH
Atmosphere	No excessive dust, smoke, corrosive gases, flammable gases, steam, or salt
Vibration	10 to 55Hz 15m/s ²
Shock	50m/s ²

■ Wiring

• Connection wires and terminal processing

Be sure to perform wiring correctly referring to the connection diagram. Main terminals for models TK26E to TK-E6 are wired using solid wires or stranded wires. Stranded wires or flexible stranded wires can be connected by twisting them together crimping a sleeve (ferrule) onto them before connecting.

• Tightening torque

If wires are not tightened sufficiently, they may become hot or come loose and result in a fire, short-circuit, electric shock, or some other potentially dangerous situation. Be sure to tighten the wires to the torques specified in the tables below.



• Wire Sizes, Tightening Tools, Tightening Torques

Main Circuit

Thermal overload relay type	TK26E
Base unit type	TZ1H26E
Solid wire (mm ²)	One 0.75 to 4 Two 1 to 4
Stranded wire (mm ²)	One 0.75 to 4 Two 1 to 4
AWG	One 12 max. Two 12 max.
Sheath stripping length (mm)	 11
Terminal screw size	M4
Tool	⊕ Phillips screwdriver, H-type, No. 2 (ISO 8764) ⊖ Flat-blade screwdriver, 1×5.5×L-type, B (ISO 2830)
Tightening torque [N·m(lb·in)]	1.2 to 1.5 (11 to 13)

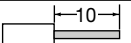
Control Circuit

Single stranded wire (mm ²)	One 0.75 to 2.5 (ø1 to ø1.6) Two 0.75 to 2.5
AWG	One 18 to 14 Two 18 to 14
Sheath stripping length (mm)	 10
Fork terminal	Max. 7.7mm wide (R2-3.5)
Terminal screw size	M3.5
Tool	⊕ Phillips screwdriver, H-type, No. 2 (ISO 8764) ⊖ Flat-blade screwdriver, 1×5.5×L-type, B (ISO 2830)
Tightening torque [N·m(lb·in)]	0.8 to 1 (7 to 9)

Thermal overload relay type	TK-E2	TK-E3	TK-E5	TK-E6, E6H
Base unit type	SZ-HDE	SZ-HEE	-	-
	Single stranded wire (mm ²) *1	0.75 to 16	1.5 to 35	16 to 70
	Flexible stranded wire with sleeve (mm ²) *1	0.75 to 16	1.5 to 35	16 to 70
	Flexible stranded wire without sleeve (mm ²)	0.75 to 16	1.5 to 35	16 to 70
	AWG	6 max.	2 max.	00 max.
	Sheath stripping length (mm)	 18	21	23
	Tool	⊕ Phillips screwdriver, H-type, No. 2 (ISO 8764) ⊖ Flat-blade screwdriver, 1×5.5×L-type, B (ISO 2830)	⊙ Hex. wrench 4 (ISO 2936)	
	Tightening torque (N·m)	2.5	6	10

Notes: *1 Stranded wire (0 to 25mm²) consists of 7 wires or less.
Stranded wire (35 to 120mm²) consists of 19 wires or less.
Flexible stranded wire consists of more number wires than the above.

Mini-Contactors SK series

Ordering Information

MSA CONTROL - (11) 3961-1171 - comercial@msacontrol.com.br

■ Type Number Nomenclature

- Type Number Nomenclature (Type Number = Product Code)
- Magnetic Contactors

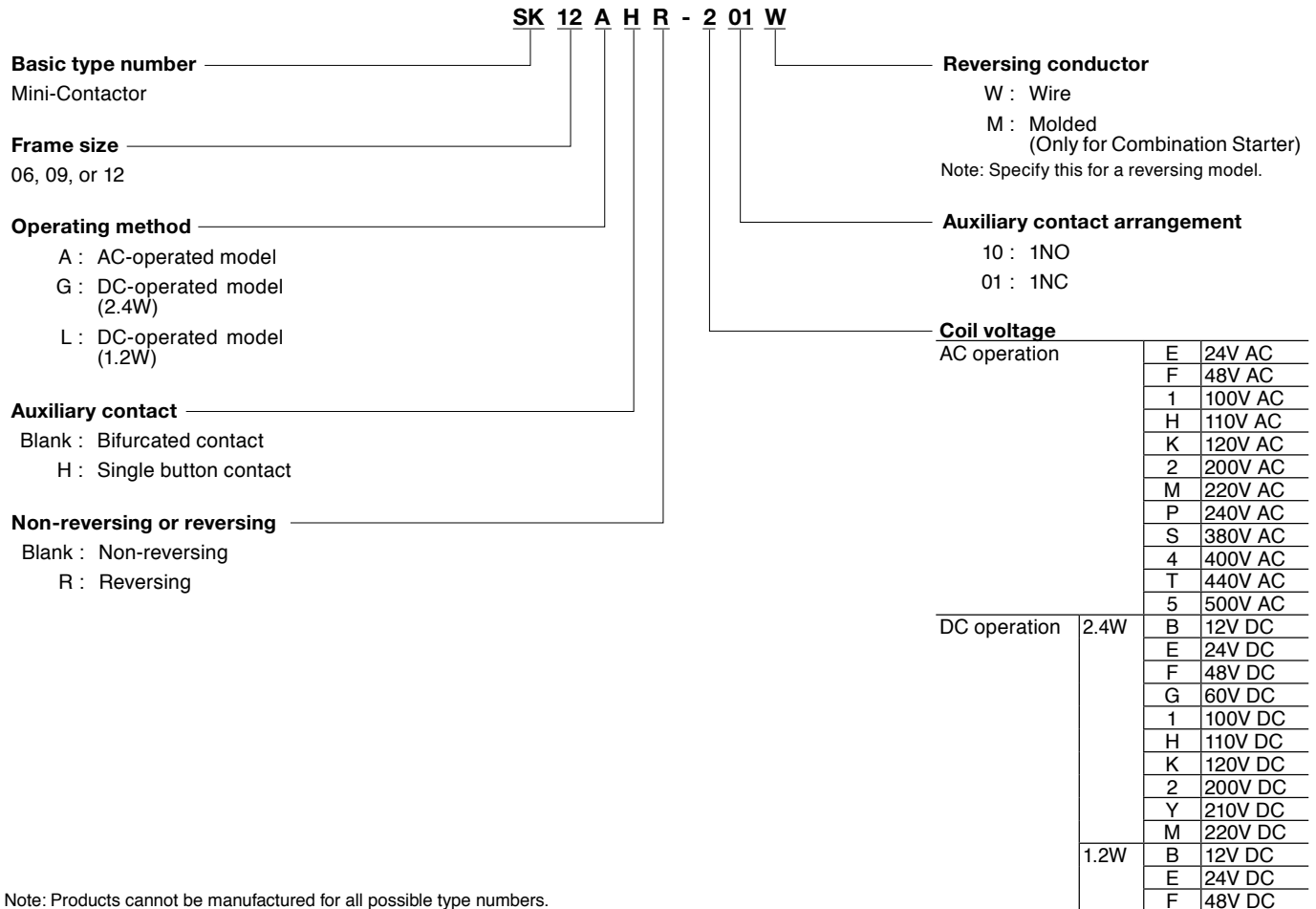

Note: Products cannot be manufactured for all possible type numbers.

Mini-Contactors SK series

Characteristics

MSA CONTROL - (11) 3961-1171 - comercial@msacontrol.com.br

Ratings

■ Main Circuit Ratings

- IEC-conformance Ratings (IEC 60947-4-1, EN 60947-4-1, and VDE 0660)

Type	Max. motor capacity [kW]				Operational current [A]						Conventional free air thermal current [A] (Rated thermal current)
	3-phase squirrel-cage motor (AC-3)				3-phase squirrel-cage motor (AC-3)				Resistance (AC-1)		
	200-240V	380-440V	500-550V	600-690V	200-240V	380-440V	500-550V	600-690V	200-240V	380-440V	
SK06	1.5	2.2	3	3	6	6	5	3.5	12	12	20
SK09	2.2	4	4	4	9	9	7	5	16	16	20
SK12	3	5.5	5.5	4	12	12	9	5	20	20	20

Note: AC-3 electrical durability: 1,000,000 operations

- UL/CSA-conformance Ratings (UL60947-4-1A and CSA C22.2)

Type	Max. motor capacity [HP]				Operational current [A]				Rated continuous current [A]
	3-phase motor				3-phase motor				
	200V	220-240V	440-480V	550-600V	200V	220-240V	440-480V	550-600V	
SK06	1-1/2	2	3	5	6.9	6.8	4.8	6.1	20
SK09	2	3	5	5	7.8	9.6	7.6	6.1	20
SK12	3	3	5	5	11	9.6	7.6	6.1	20

Type	Max. motor capacity [HP]			Operational current [A]			Rated continuous current [A]
	Single-phase motor			Single-phase motor			
	110-120V	200V	220-240V	110-120V	200V	220-240V	
SK06	1/2	3/4	1	9.8	7.9	8	20
SK09	3/4	1	1-1/2	13.8	9.2	10	20
SK12	1	1-1/2	2	16	11.5	12	20

Note: Use wires that are rated for 75°C.

Mini-Contactors SK series

Characteristics

MSA CONTROL - (11) 3961-1171 - comercial@msacontrol.com.br

■ Auxiliary Circuit Ratings

● IEC-conformance Ratings (Standard Models: Bifurcated Contact)

Type	Conventional free air thermal current [A] (Rated thermal current)	Making and breaking current (AC)	Rated operational current [A]						Minimum voltage and current
			AC rated operational voltage [V]	AC-15 (Ind. load)	AC-12 (Res. load)	DC rated operational voltage [V]	DC-13 (Ind. load)	DC-12 (Res. load)	
SK06 SK09 SK12	10	30	100-120	3	6	24	2	3	5V DC, 3mA
		30	200-240	3	6	48	1	2	
		10	380-440	1	6	110	0.3	1.5	
		5	500-600	0.5	3	220	0.2	0.5	

Note: The failure level is 10^{-7} for a normal environment without dust, dirt, or corrosive gas.
The ratings of additional auxiliary contacts are the same as those given above.

● IEC-conformance Ratings (Single Button Contact)

Type	Conventional free air thermal current [A] (Rated thermal current)	Making and breaking current (AC)	Rated operational current [A]						Minimum voltage and current
			AC rated operational voltage [V]	AC-15 (Ind. load)	AC-12 (Res. load)	DC rated operational voltage [V]	DC-13 (Ind. load)	DC-12 (Res. load)	
SK06□H SK09□H SK12□H	10	60	100-120	6	10	24	4	8	24V DC, 10mA
		60	200-240	6	10	48	1	3.5	
		60	380-440	6	10	110	0.5	2.5	
		30	500-600	3	5	220	0.25	0.8	

Note: The failure level is 10^{-7} for a normal environment without dust, dirt, or corrosive gas.
The ratings of additional auxiliary contacts are the same as those given above.

● UL/CSA-conformance Ratings (Bifurcated Contact or Single Button Contact)

Type	Rated continuous current [A]	Rated operational current [A]						Rating code	
		AC			DC			AC	DC
		Rated operational voltage [V]	Making	Breaking	Rated operational voltage [V]	Making	Breaking		
SK06 SK09 SK12	10	120	60	6	125	0.55	0.55	A600	Q300
		240	30	3					
		480	15	1.5	250	0.27	0.27		
		600	12	1.2					

Mini-Contactors SK series

Characteristics

MSA CONTROL - (11) 3961-1171 - comercial@msacontrol.com.br

■ Operating Coil Voltages

● AC-operated Models

Type	Order voltage	Code	Coil voltage and frequency
SK06A SK09A SK12A	24V AC	E	24V 50Hz / 24-26V 60Hz
	48V AC	F	48V 50Hz / 48-52V 60Hz
	100V AC	1	100V 50Hz / 100-110V 60Hz
	110V AC	H	100-110V 50Hz / 110-120V 60Hz
	120V AC	K	110-120V 50Hz / 120-130V 60Hz
	200V AC	2	200V 50Hz / 200-220V 60Hz
	220V AC	M	200-220V 50Hz / 220-240V 60Hz
	240V AC	P	220-240V 50Hz / 240-260V 60Hz
	380V AC	S	346-380V 50Hz / 380-420V 60Hz
	400V AC	4	380-400V 50Hz / 400-440V 60Hz
	440V AC	T	415-440V 50Hz / 440-480V 60Hz
500V AC	5	480-500V 50Hz / 500-550V 60Hz	

● DC-operated Models (2.4W)

Type	Order voltage	Code	Coil voltage
SK06G SK09G SK12G	12V DC	B	12V DC
	24V DC	E	24V DC
	48V DC	F	48V DC
	60V DC	G	60V DC
	100V DC	1	100V DC
	110V DC	H	110V DC
	120V DC	K	120V DC
	200V DC	2	200V DC
	210V DC	Y	210V DC
	220V DC	M	220V DC

● DC-operated Models (1.2W)

Type	Order voltage	Code	Coil voltage
SK06L SK09L SK12L	12V DC	B	12V DC
	24V DC	E	24V DC
	48V DC	F	48V DC

Mini-Contactors SK series

Characteristics

MSA CONTROL - (11) 3961-1171 - comercial@msacontrol.com.br

■ Operating Coil Characteristics

● AC-operated Models

Type	Power consumption [VA]				Watt loss [W]		Pick-up voltage [V]		Drop-out voltage [V]		Operating times [ms]	
	Inrush		Sealed								Coil ON Contact ON	Coil OFF Contact OFF
SK06A SK09A SK12A	200V 50Hz	220V 60Hz	200V 50Hz	220V 60Hz	200V 50Hz	220V 60Hz	50Hz	60Hz	50Hz	60Hz	17-26	8-11
	22	25	4.5	4.5	1.2	1.3	122-135	128-138	80-89	83-96		

Note 1. The characteristics are for the following coil ratings: 200V, 50Hz/200 to 220V, 60Hz.

Note 2. The electromagnet capacity is the same even when the rated coil voltage is not 200V AC.

Note 3. The operating times are for 200V AC, 50Hz.

Note 4. The pick-up voltage and drop-out voltage for a 100V (100V AC, 50 Hz/100 to 110V, 60Hz) coil are approximately half of the values that are given in the above table.

Note 5. The values in the above table are examples for a cold status at 20°C.

● DC-operated Models (2.4W)

Type	Power consumption [W]		Time constant [ms]	Pick-up voltage [V]	Drop-out voltage [V]	Operating times [ms]	
	Inrush	Sealed				Coil ON Contact ON	Coil OFF Contact OFF
SK06G SK09G SK12G	24V	24V	Sealed				
	2.4	2.4	20	10-11	4-6	22-24	5-6

Note 1. The characteristics are for the following coil rating: 24V DC.

Note 2. The electromagnet capacity is the same even when the rated coil voltage is not 24V DC.

Note 3. The values in the above table are examples for a cold status at 20°C.

● DC-operated Models (1.2W)

Type	Power consumption [W]		Time constant [ms]	Pick-up voltage [V]	Drop-out voltage [V]	Operating times [ms]	
	Inrush	Sealed				Coil ON Contact ON	Coil OFF Contact OFF
SK06L SK09L SK12L	24V	24V	Sealed				
	1.2	1.2	20	13-14	4-5	30-33	8-9

Note 1. The characteristics are for the following coil rating: 24V DC.

Note 2. The electromagnet capacity is the same even when the rated coil voltage is not 24V DC.

Note 3. The values in the above table are examples for a cold status at 20°C.

Mini-Contactors SK series

Characteristics

MSA CONTROL - (11) 3961-1171 - comercial@msacontrol.com.br

■ Performances

Type	Rated operational voltage [V]	Rated operational current [A]	Making/breaking current [A]		Operating cycles per hour [times/hour]	Durability (Operations)	
			Making	Breaking		Mechanical	Electrical
SK06	220	6	72	60	1800	10 million	1 million
	440	6	72	60			
SK09	220	9	108	90			
	440	9	108	90			
SK12	220	12	144	120			
	440	12	144	120			

■ AC-3 Breaking Current and Electrical Durability

● SK06 to SK12

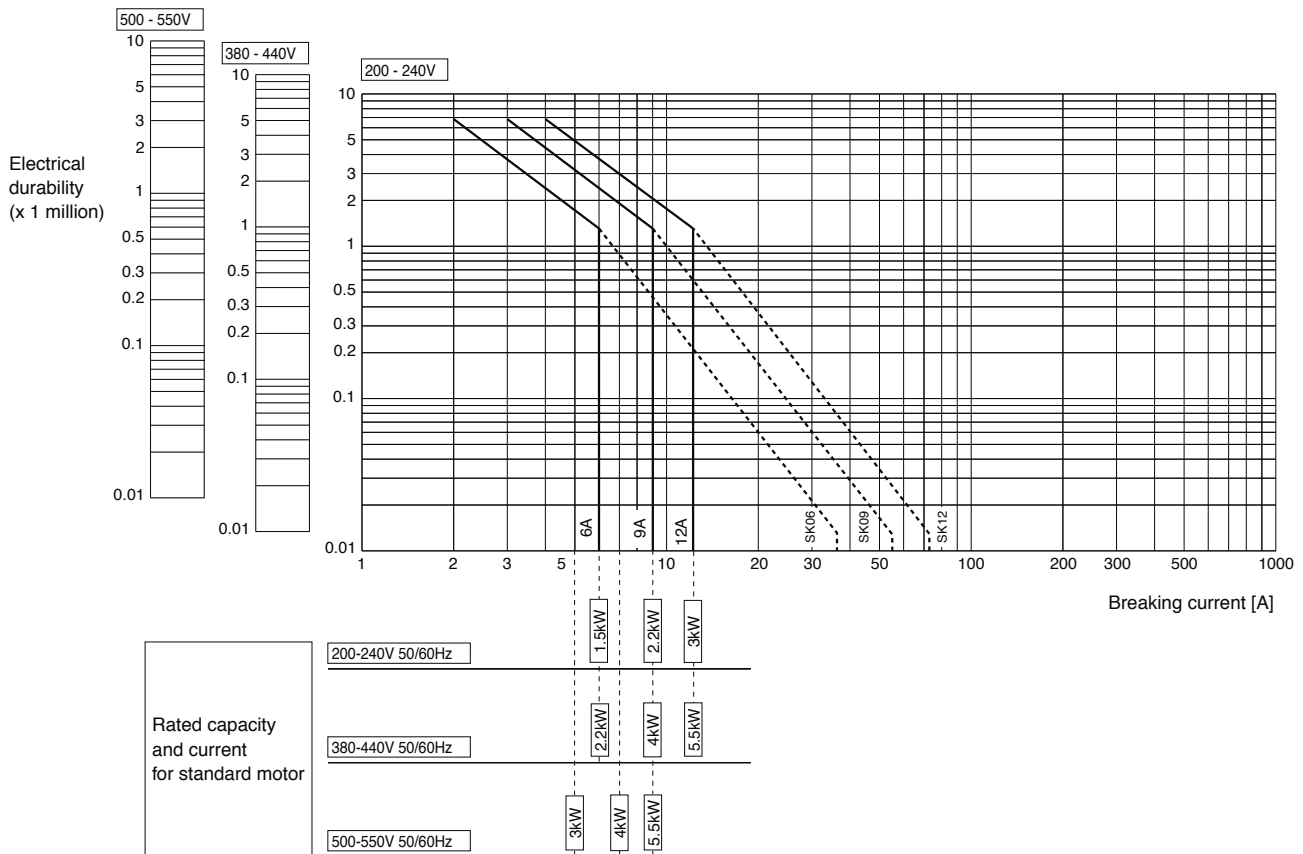

MSA CONTROL - (11) 3961-1171 - comercial@msacontrol.com.br

■ AC-1 Breaking Current and Electrical Durability

- SK06 to SK12

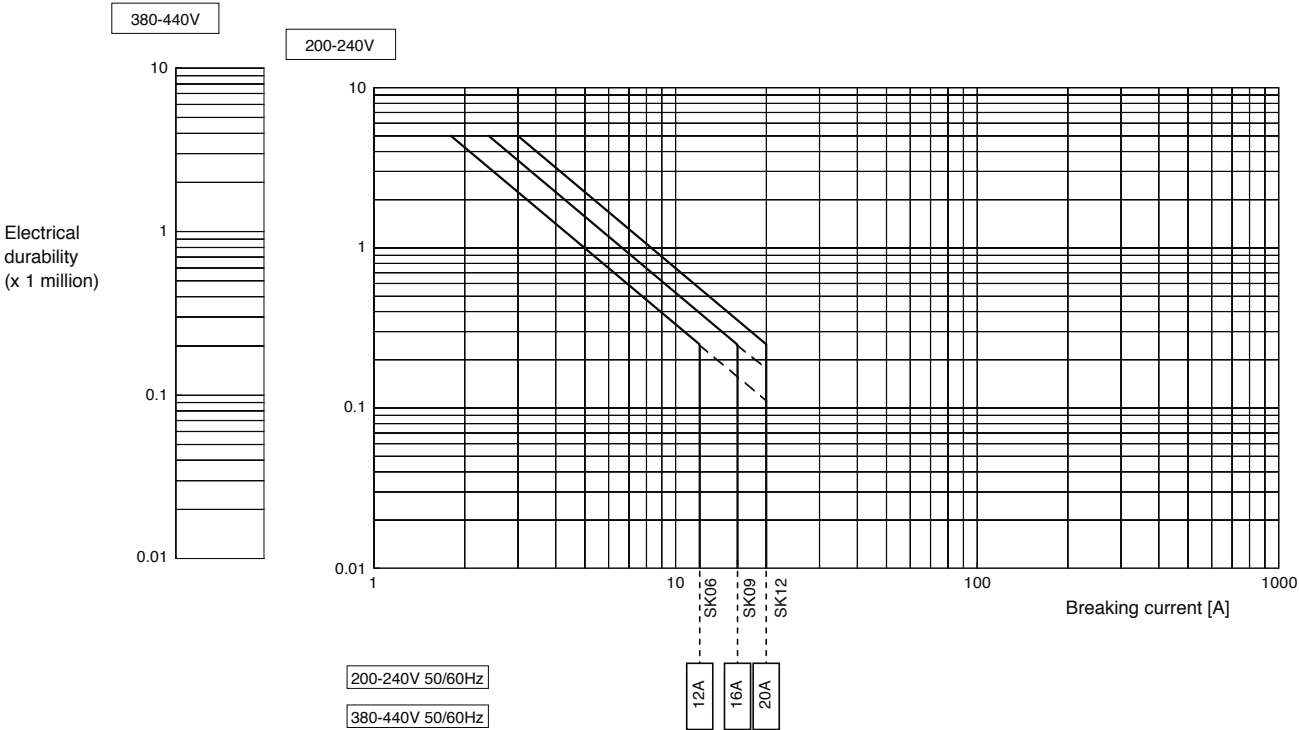

Mini-Contactors SK series

Optional Accessories

MSA CONTROL - (11) 3961-1171 - comercial@msacontrol.com.br

Optional Unit

■ Type Numbers and Product Codes

Product name	Type	Specification	Used with
Auxiliary Contact Blocks (Front mounting, Bifurcated Contact)	SZ1KA40	Contact arrangement: 4NO	SK06 to SK12 *1
	SZ1KA31	Contact arrangement: 3NO+1NC	
	SZ1KA22	Contact arrangement: 2NO+2NC	
	SZ1KA13	Contact arrangement: 1NO+3NC	
	SZ1KA04	Contact arrangement: 4NC	SK06 to SK12
	SZ1KA20	Contact arrangement: 2NO	
	SZ1KA11	Contact arrangement: 1NO+1NC	
	SZ1KA02	Contact arrangement: 2NC	
Auxiliary Contact Blocks (Front mounting, Single Button Contact)	SZ1KA40H	Contact arrangement: 4NO	SK06 to SK12 *1
	SZ1KA31H	Contact arrangement: 3NO+1NC	
	SZ1KA22H	Contact arrangement: 2NO+2NC	
	SZ1KA13H	Contact arrangement: 1NO+3NC	
	SZ1KA04H	Contact arrangement: 4NC	SK06 to SK12
	SZ1KA20H	Contact arrangement: 2NO	
	SZ1KA11H	Contact arrangement: 1NO+1NC	
	SZ1KA02H	Contact arrangement: 2NC	
Auxiliary Contact Blocks (Small Front mounting, Bifurcated Contact)	SZ1FA11	Contact arrangement: 1NO+1NC	SK06 to SK12
Auxiliary Contact Blocks (Small Front mounting, Single Button Contact)	SZ1FA11H	Contact arrangement: 1NO+1NC	SK06 to SK12
Mechanical Interlock Units	SZ1KRM	Reversing assembly and mechanical interlock	SK06 to SK12
Reversing Connection Kit (wiring)	SZ1KRW1W	Reversing Connection Kit for main circuit	SK06 to SK12
Main Circuit Surge Suppression Unit *2	SZ-ZM2	Built-in CR (3-phase motor, 200V, 0.1 to 2.2kw)	SK06 to SK12
Standalone Installation Unit *2 (for Main Circuit Surge Suppression Unit)	SZ-ZMH	For Main Circuit Surge Suppression Unit	SZ-ZM2
Coil Surge Suppression Units (surge suppression only)	SZ1KZ1	Built-in varistor: 24 to 48V AC/DC	SK06 to 12
	SZ1KZ2	Built-in varistor: 48 to 125V AC/DC	
	SZ1KZ3	Built-in varistor: 100 to 240V AC/DC	
Coil Surge Suppression Units (with Operation Indicator Lamps)	SZ1KZ4	Built-in varistor and LED: 24 to 48V AC/DC	SK06 to SK12
	SZ1KZ5	Built-in varistor and LED: 48 to 125V AC/DC	
Operation Indicator Units	SZ1KL1	Built-in LED: 12 to 24V AC/DC	SK06 to SK12
	SZ1KL2	Built-in LED: 24 to 48V AC/DC	
	SZ1KL3	Built-in LED: 48 to 125V AC/DC	
Thermal Overload Relay Reset Releases	SZ-R1	Release length: 300mm	TK12
	SZ-R2	Release length: 500mm	
	SZ-R3	Release length: 700mm	
Link Module	BZ0LRK12AA	Links to Manual Motor Starter	SK06 to SK12
Reversing Connection Unit (Insert)	SZ1KRW1M	Reversing Connection Unit (Insert) for main circuit	SK06 to SK12

*1 These options cannot be used with 1.2W DC Magnetic Contactors and Starters from SK06 to SK12L.

*2 Use the SZ-ZM2 Main Circuit Surge Suppression Unit together with the SZ-ZMH Standalone Installation Unit.

MSA CONTROL - (11) 3961-1171 - comercial@msacontrol.com.br

Auxiliary Contact Blocks

■ Features

- Easily add on auxiliary contacts.
- You can add auxiliary contacts without increasing the footprint to contribute to control panel downsizing.
- Many different contact variations in two external sizes.
- Models with double contacts are available for high reliability to achieve a minimum operating voltage and current of 5V DC, 3mA.

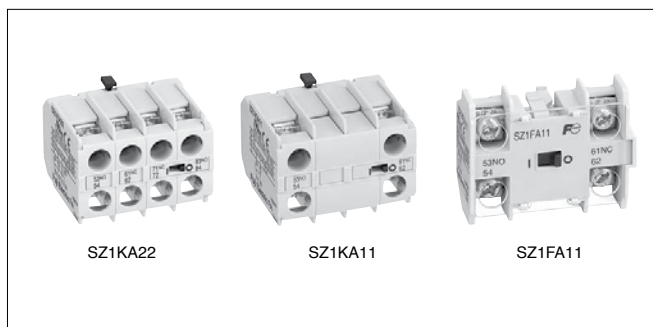

■ Ordering Information (Types)

- Auxiliary Contact Blocks

SZ1KA22

① Type

■ Ordering Information (Types)

Product name	Number of contacts	Contact arrangement	Mounting	Used with	Type	
Auxiliary Contact Blocks with Bifurcated Contacts	4	4NO	Front mounting	SK06 to SK12 *1	SZ1KA40	
		3NO+1NC			SZ1KA31	
		2NO+2NC			SZ1KA22	
		1NO+3NC			SZ1KA13	
		4NC			SZ1KA04	
	2	2NO	Front mounting	SK06 to SK12	SZ1KA20	
		1NO+1NC			SZ1KA11	
		2NC			SZ1KA02	
	Auxiliary Contact Blocks with Single Contacts	4	4NO	Front mounting	SK06 to SK12 *1	SZ1KA40H
			3NO+1NC			SZ1KA31H
2NO+2NC			SZ1KA22H			
1NO+3NC			SZ1KA13H			
4NC			SZ1KA04H			
2		2NO	Front mounting	SK06 to SK12	SZ1KA20H	
		1NO+1NC			SZ1KA11H	
		2NC			SZ1KA02H	
Small Auxiliary Contact Block with Bifurcated Contacts		2	1NO+1NC	Front mounting	SK06 to SK12	SZ1FA11
Small Auxiliary Contact Block with Single Contacts		2	1NO+1NC	Front mounting	SK06 to SK12	SZ1FA11H

*1These options cannot be used with 1.2W DC Magnetic Contactors and Starters from SK06 to SK12L.

■ Ratings

Type	Conventional free air thermal current (Rated continuous current) [A]	Making and breaking current (AC) [A]	Rated operational current [A]						Minimum voltage and current
			AC			DC			
			Rated operational voltage [V]	Ind. load (AC-15)	Res. load (AC-12)	Rated operational voltage [V]	Ind. load (DC-13)	Res. load (DC-12)	
SZ1KA□ SZ1FA□ (Bifurcated contacts)	10	30	AC100 - 120	3	6	24 DC	2	3	5V DC, 3mA
			AC200 - 240	3	6	48 DC	1	2	
			AC380 - 440	1	6	110 DC	0.3	1.5	
			AC500 - 600	0.5	3	220 DC	0.2	0.5	
SZ1KA□H SZ1FA□H (Single contacts)	10	60	AC100 - 120	6	10	24 DC	4	8	24V DC, 10mA
			AC200 - 240	6	10	48 DC	1	3.5	
			AC380 - 440	6	10	110 DC	0.5	2.5	
			AC500 - 600	3	5	220 DC	0.25	0.8	

Mini-Contactors SK series

Optional Accessories

MSA CONTROL - (11) 3961-1171 - comercial@msacontrol.com.br

■ Dimensions, mm

- SZ1KA40
- SZ1KA31
- SZ1KA22
- SZ1KA13
- SZ1KA04
- SZ1KA40H
- SZ1KA31H
- SZ1KA22H
- SZ1KA13H
- SZ1KA04H

4-pole

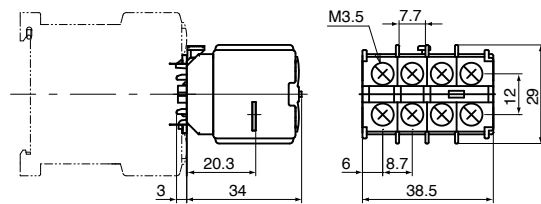

Mass : 34g

Type	Contact arrangement
SZ1KA40 SZ1KA40H	4NO
SZ1KA31 SZ1KA31H	3NO+1NC
SZ1KA22 SZ1KA22H	2NO+2NC
SZ1KA13 SZ1KA13H	1NO+3NC
SZ1KA04 SZ1KA04H	4NC

- SZ1KA20
- SZ1KA11
- SZ1KA02
- SZ1KA20H
- SZ1KA11H
- SZ1KA02H

2-pole

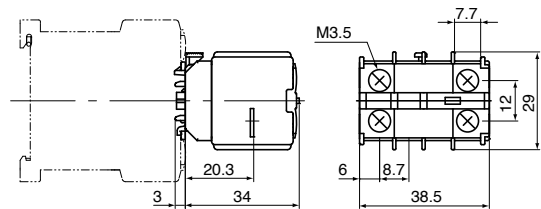

Mass : 29g

Type	Contact arrangement
SZ1KA20 SZ1KA20H	2NO
SZ1KA11 SZ1KA11H	1NO+1NC
SZ1KA02 SZ1KA02H	2NC

- SZ1FA11
- SZ1FA11H

Small,
2-pole

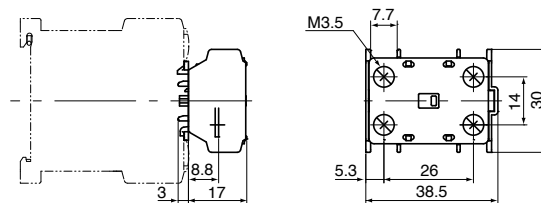

Mass : 17g

Type	Contact arrangement
SZ1FA11 SZ1FA11H	1NO+1NC

MSA CONTROL - (11) 3961-1171 - comercial@msacontrol.com.br

Mechanical Interlock Unit and Power Connection Kit for Reversing

■ Features

- Mechanically prevent two Magnetic Contactors from turning ON at the same time.
- Combine a Reversing Connection Kit with an Interlock Unit to easily configure a reversing Magnetic Contactors.
- Mounting two Magnetic Contactors on the front surface reduces the mounting footprint and contributes to downsizing control panels.

■ Types

- Mechanical Interlock Unit: Joins two Magnetic Contactors to mechanically lock them.

Product name	Used with	Type
Mechanical Interlock Unit	SK06, SK09, and SK12	SZ1KRM

- Power Connection Kit for Reversing: Used to reverse the circuit wiring between the main circuit terminals.

Product name	Wire size	Number of conductors per set	Used with	Type
Power Connection Kit for Reversing	AWG14 (1.6 dia.)	<ul style="list-style-type: none"> • One set for power supply side • One set for load side 	SK06, SK09, and SK12	SZ1KRW1W

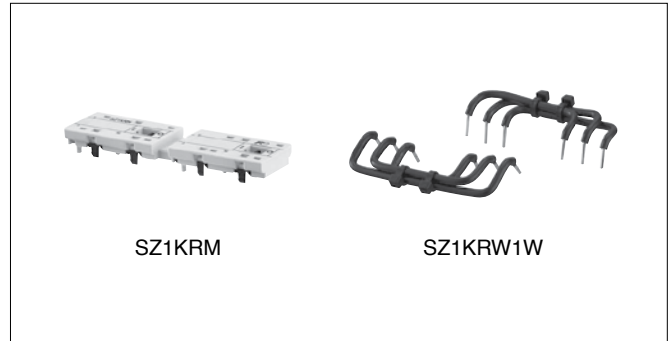

■ Dimensions, mm

- Mechanical Interlock Unit

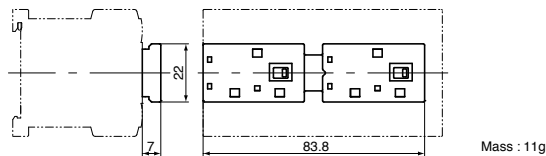

- Power Connection Kit for Reversing

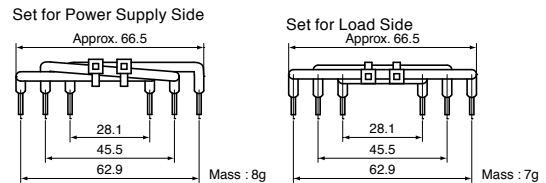

■ Mounting Procedures

- Interlock Unit

- (1) Connect two Magnetic Contactors with the two connection pieces ①.
- (2) Move the moveable projections ② on the Interlock Unit to the right side.
- (3) Insert the Interlock Unit directly from the top so that it is aligned with the projections ③ on the moveable portion on the Magnetic Contactors.
- (4) After you mount the Interlock Unit, slide the projection on the indicator window on the right side and then on the left side to confirm that they move smoothly.

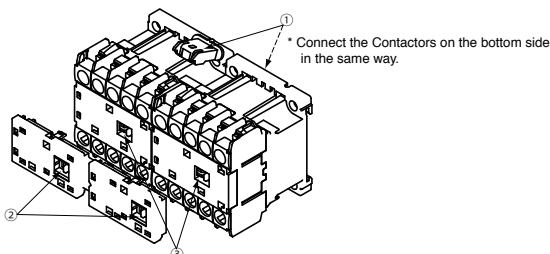

- Power Connection Kit for Reversing

Connect the Kit to the main circuit terminals. There are wires for the power supply side and wires for the load side. Be sure to connect them to the correct sides.

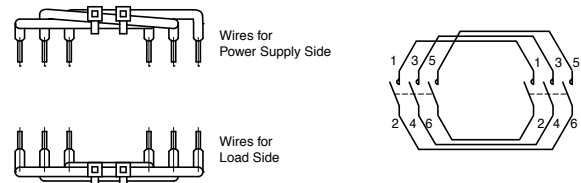

⚠ Caution Precaution for Correct Use

- When the Magnetic Contactors are switched rapidly, use an electrically interlock, such as a delay relay, to ensure a switching time of at least 15ms for the contacts of the two Magnetic Contactors.

Mini-Contactors SK series

Optional Accessories

MSA CONTROL - (11) 3961-1171 - comercial@msacontrol.com.br

Main Circuit Surge Suppression Unit and Separate Installation Unit

■ Features

- Absorbs the surge voltage that is generated from three-phase motors when the Magnetic Contactor is switched to suppress the effects of surge voltage.
- Combination with a Separate Installation Unit enables both screw mounting and DIN rail mounting. (The SZ-ZM2 Main Circuit Surge Suppression Unit must be used with a Separate Installation Unit to secure it.)

■ Ratings and Types

Product name	Rated voltage and frequency	Applicable 3-phase motors	Type
Main Circuit Surge Suppression Unit	250V AC, 50/60Hz	200 to 240V AC, 0.1 to 2.2kW	SZ-ZM2
Separate Installation Unit	-	-	SZ-ZMH

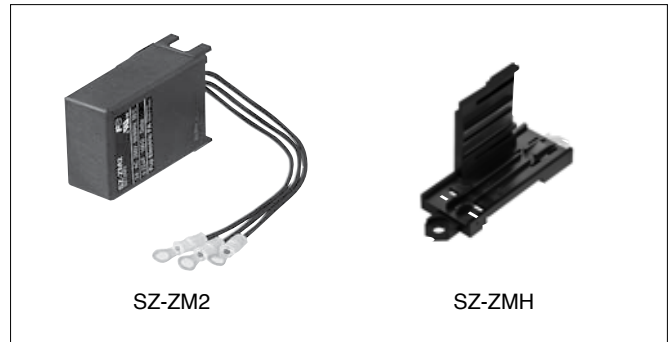

■ Performances

Item		Performance
Dielectric strength	Between terminals	Rated voltage × 230% for 1 min
	Between terminals and Unit outer case	Rated voltage × 2 + 1,000V for 1 min
Insulation resistance	Between terminals	2,000MΩ min.
	Between terminals and Unit outer case	2,000MΩ min. per terminal
Electrostatic capacity tolerance (at 1kHz)		±10%
Durability		1 million operations

■ Mounting Procedures

- Combining the Main Circuit Surge Suppression Unit and Separate Installation Unit
Align projections ① on the Main Circuit Surge Suppression Unit with the mounting grooves ② on the inner surface of the Separate Installation Unit and press in firmly in the direction indicated by the arrow until the Units click into place.

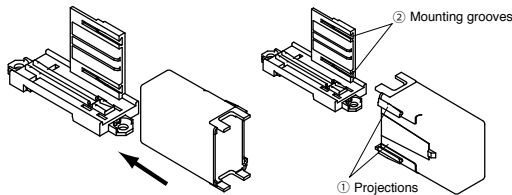

● Mounting to a Rail

- (1) Catch the black hook on the top of the Unit on the rail.
- (2) Press down on the Unit and press it against the rail, and latch the bottom hook on the rail.

* Always attach the Main Circuit Surge Suppression Unit with the Separate Installation Unit before mounting them to the rail.

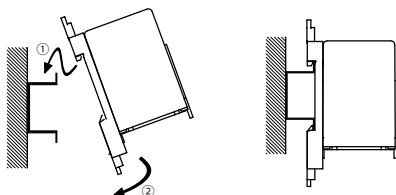

● Connection to the Magnetic Contactor

To connect the Main Circuit Surge Suppression Unit to the Magnetic Contactor, attach each of the terminals 2, 4, and 6 on the load side of the Magnetic Contactor to any of the leads on the Unit.

■ Main Circuit Surge Suppression Characteristics

(220V AC, 2.2kW motor)

- Without Main Circuit Surge Suppression Unit

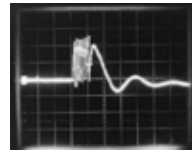

(No.CP-485)

- With Main Circuit Surge Suppression Unit

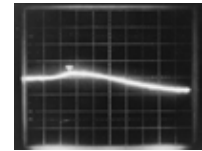

(No.CP-486)

■ Dimensions, mm

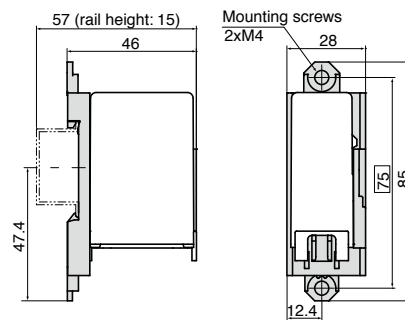

■ Circuit Connection Diagram

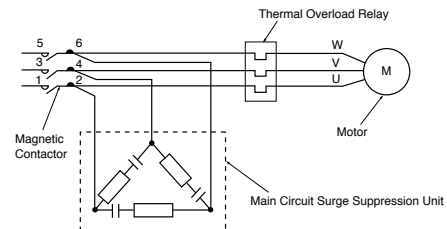

⚠ Caution Precaution for Correct Use

- Do not use the Main Circuit Surge Suppression Unit near inverter circuits or in other locations where a large harmonic component is present.

MSA CONTROL - (11) 3961-1171 - comercial@msacontrol.com.br

Coil Surge Suppression Units and Operation Indicator Lamps

■ Features

- The Main Circuit Surge Absorber Unit absorbs the surge voltage that is generated when the coil in a Magnetic Contactor turns OFF. This suppresses malfunctioning of electronic circuits.
- The Operation Indicator Unit indicates with an LED when voltage is applied to the coil terminals.

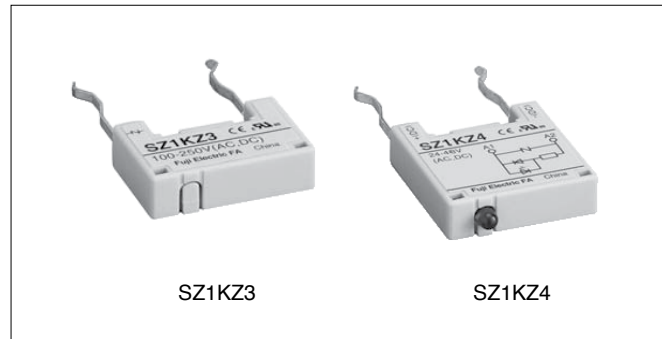

■ Ratings and Types

Product name	Surge suppression element	Specification	Operation indicator lamp	Control circuit voltage		Type
				AC	DC	
Coil Surge Suppression Units	Varistor	Varistor voltage: 100V	-	24-48V	Not required	SZ1KZ1
		Varistor voltage: 240V		48-125V	*	SZ1KZ2
		Varistor voltage: 470V		100-250V		SZ1KZ3
		Varistor voltage: 100V		24-48V	Not required	SZ1KZ4
Operation Indicator Units	-	-	LED (red)	48-125V	*	SZ1KZ5
				12-24V	12-24V	SZ1KL1
				24-48V	24-48V	SZ1KL2
				48-125V	48-125V	SZ1KL3

Note: * A varistor is built into the SK□G and SK□L for DC operation.

■ Coil Surge Suppression Characteristics

Product	Application	Characteristics (200V AC coil)
Without Surge Suppression Unit	A sharp surge voltage is generated from the coil due to coil inductance as a result of the rapid change in voltage when the coil turns OFF. This becomes noise to surrounding electronic devices, and can cause malfunctions and circuit destruction.	<p>SK12A</p> <p>(0.1ms/div, 1kV/div)</p>
Models with varistors built in	When the surge voltage reaches a certain level, current flows to the varistor that is connected in parallel with the coil. This serves to control the peak surge voltage. Varistors can be applied to either AC or DC. The suppressed surge voltage is approximately the varistor voltage.	<p>SK12A + SZ1KZ3</p> <p>(2ms/div, 200V/div)</p>

■ Mounting methods

- (1) Insert the Unit into the mounting holes in the Magnetic Contactor. The Unit must be oriented properly top to bottom. Do not mount the Unit backwards.

- Mounting to Non-reversing Magnetic Contactors

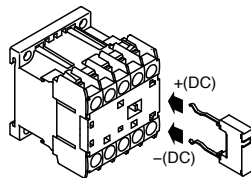

- Mounting to Reversing Magnetic Contactors

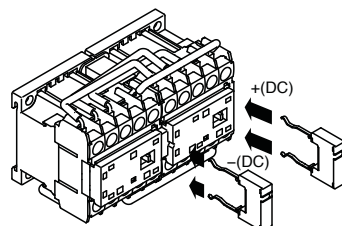

■ Dimensions, mm

- SZ1KZ1 to SZ1KZ3 (Coil Surge Suppression Units)

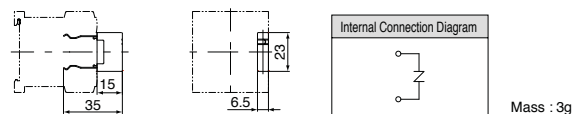

- SZ1KZ4 and SZ1KZ5 (Coil Surge Suppression Units with Operation Indicator Lamps)

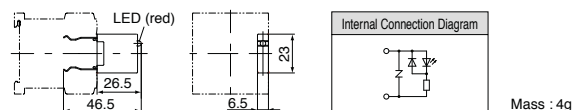

- SZ1KL1 to SZ1KL3 (Operation Indicator Units)

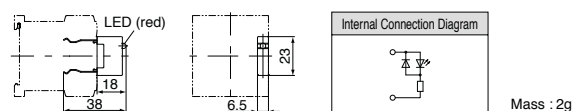

Mini-Contactors SK series

Dimensions

MSA CONTROL - (11) 3961-1171 - comercial@msacontrol.com.br

■ Dimensions, mm

- Magnetic Contactors
- SK06□, SK09□, SK12□

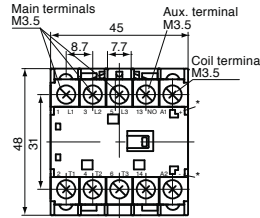
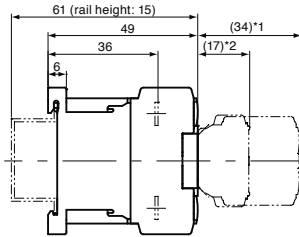

Mounting Hole Dimensions

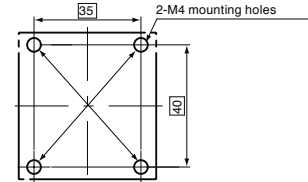

[NOTES]
 *1 With SZ1KA□ Auxiliary Contact Blocks.
 *2 With SZ1FA□ Auxiliary Contact Blocks.

[NOTE]
 Mount the Auxiliary Overload Relay with two mounting holes in diagonally opposed corners.

Mass : 0.14kg (For AC-operated models.)
 0.17kg (For DC-operated models.)

Wiring diagram

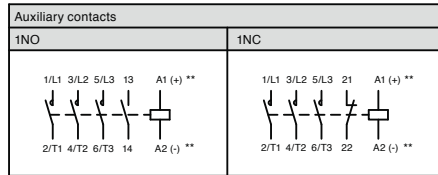

** For DC-operated models.

- Magnetic Contactors
- SK06□ R, SK09□ R, SK12□ R

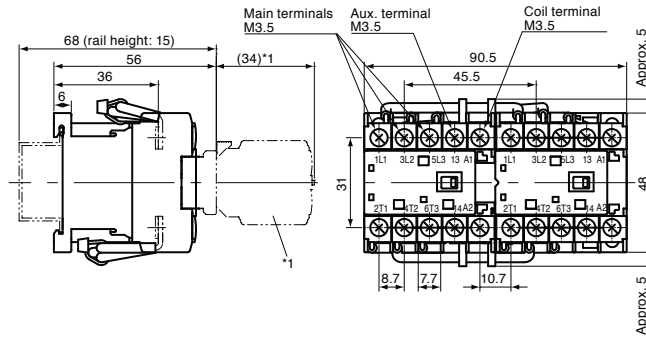

Mounting Hole Dimensions

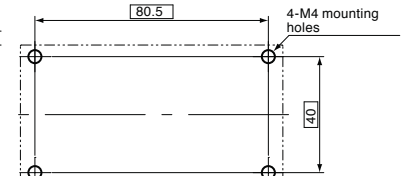

Mass : 0.32kg (AC-operated model)
 0.38kg (DC-operated model)

Wiring diagram

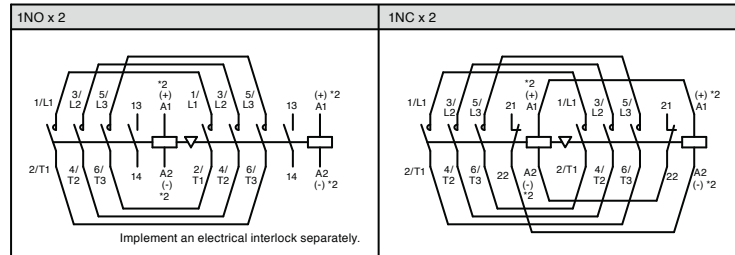

[NOTE]
 *1 With Auxiliary Contact Blocks.
 *2 For DC-operated models.

Thermal Overload Relay TK12 series

Ordering Information

MSA CONTROL - (11) 3961-1171 - comercial@msacontrol.com.br

• Thermal Overload Relays

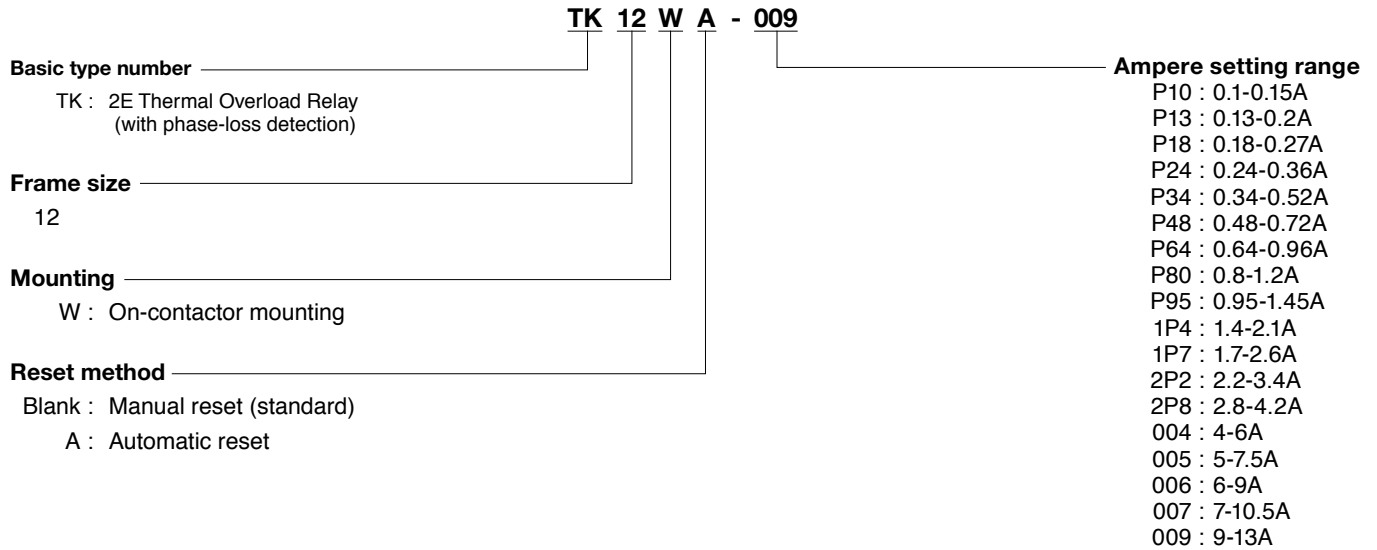

Thermal Overload Relay TK12 series

Characteristics

MSA CONTROL - (11) 3961-1171 - comercial@msacontrol.com.br

■ Auxiliary Circuit Ratings

● Ratings for IEC Standard Compliance

Type	Conventional free air thermal current [A] (Rated continuous current)	Rated operational current [A]				Rated operational voltage [V]		Minimum voltage and current
		AC-15 (Ind. load)		DC-13 (Ind. load)		AC-15 (Ind. load)	DC-13 (Ind. load)	
		NC contacts	NO contacts	NC contacts	NO contacts			
TK12	5	24	3 (0.5)	3 (0.5)	1.1(0.3)	1.1 (0.3)	DC5V, 3mA	
		100-120	2.5 (0.5)	2.5 (0.5)	0.28	0.28		
		200-240	2 (0.5)	1.5 (0.5)	0.14	0.14		
		380-440	1 (0.5)	0.75 (0.5)	–	–		
		500-600	0.6 (0.5)	0.6 (0.5)	–	–		

Numbers in brackets () are for automatic reset.

● Ratings for UL and CSA Standard Compliance

Type	Rated continuous current [A]	Rated operational current [A]						Rating code	
		AC			DC			AC	DC
		Rated operational voltage [V]	Making	Breaking	Rated operational voltage [V]	Making	Breaking		
TK12	5	120	30	3	125	0.22	0.22	B600	R300
		240	15	1.5					
		480	7.5	0.75	250	0.11	0.11		
		600	6	0.6					

■ Operating Characteristics (Specifications)

● 3-pole Circuits

Standard	Operating limit		Overload (hot start)	Locked rotor (cold start)	Ambient temperature
	Non-tripping	Tripping			
IEC 60947-4-1	105% I _e (for less than 2h)	120% I _e (for less than 2h)	Tripping class 10A: 150% I _e for less than 2min	Tripping class 10A: 720% I _e for 2 to 10 s max.	20°C

● 2-pole Circuits

Standard	Phase-loss protection	Non-tripping	Operation (hot start)	Ambient temperature
IEC 60947-4-1	Provided.	2-pole: 100% I _e 1-pole: 90% I _e	{ 2-pole: 115% I _e (for less than 2h) 1-pole: 0% I _e	20°C

■ Operating Characteristics Curves (Average Values)

● Tripping Class 10A

TK12 series, Ambient temperature: 20°C

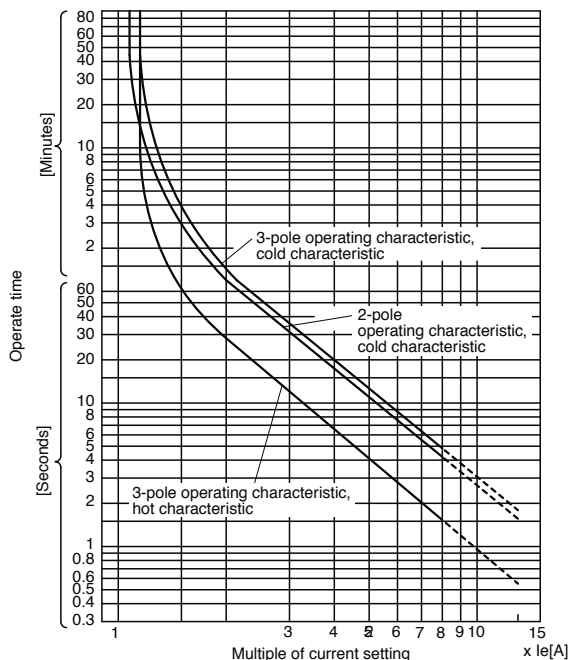

Thermal Overload Relay Reset Releases

Optional Accessories

MSA CONTROL - (11) 3961-1171 - comercial@msacontrol.com.br

Thermal Overload Relay Reset Releases

■ Features

- A Reset Release is used to enable resetting a Thermal Relay from the front surface of the panel or from a remote location.

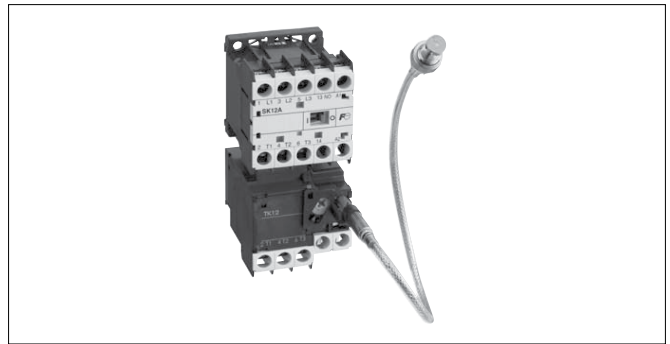

■ Ratings and Types

Product name	Release length [mm]	Mass [g]	Used with	Type
Thermal Overload Relay Reset Releases	300	30	2E Thermal Overload Relay	SZ-R1
	500	40	TK12 (Packaged together with Reset Releases for the TR-0N and 5-1N.)	SZ-R2
	700	50		SZ-R3

■ Mounting Procedure

● SZ-R1, R2, R3

- (1) Remove the front cover.

The cover can be easily removed as shown in the figure if you hold the cover near the hinges and pull strongly.

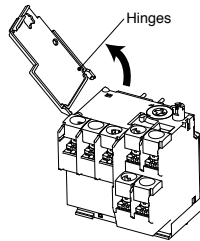

- (2) Insert the tab ① on the mounting base into the hole in the Thermal Relay and then latch the tabs ② and ③. To remove the mounting base, use a fine screwdriver to disengage tabs ② and ③.

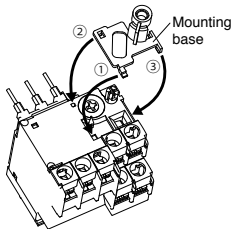

- (3) Tighten the male thread ④ on the Release in the female thread ⑤ on the mounting base. Remove the nut ⑥ from the Release, insert the Release through the panel from the back of the panel, and tighten the nut ⑥ from the front of the panel to secure the Release.

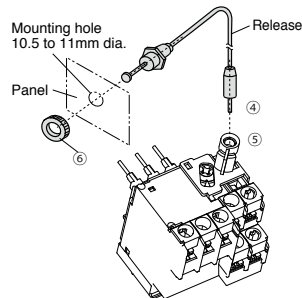

■ Dimensions, mm

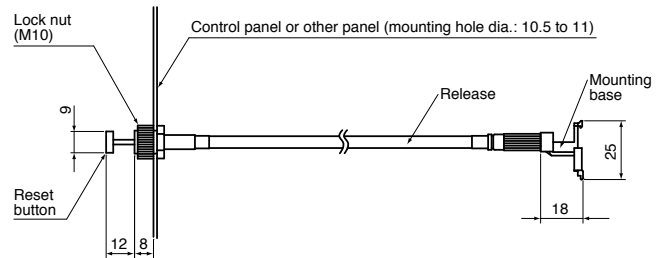

⚠ Caution Precaution for Correct Use

- When mounting the Release, do not allow the lead to bend within 25mm from the panel and within 35mm of the mounting base.
- Do not bend the lead of the Release to a radius of less than 15mm. (Refer to the figure on the right.)
- Prepare a mounting hole with a diameter of 10.5 to 11mm.

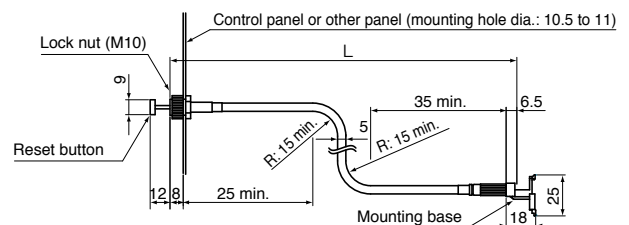

Thermal Overload Relays TK 12 series

Dimensions

MSA CONTROL - (11) 3961-1171 - comercial@msacontrol.com.br

■ Dimensions, mm



TK12

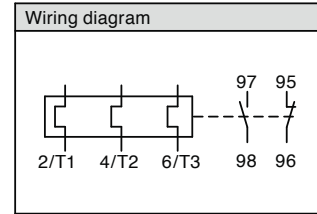
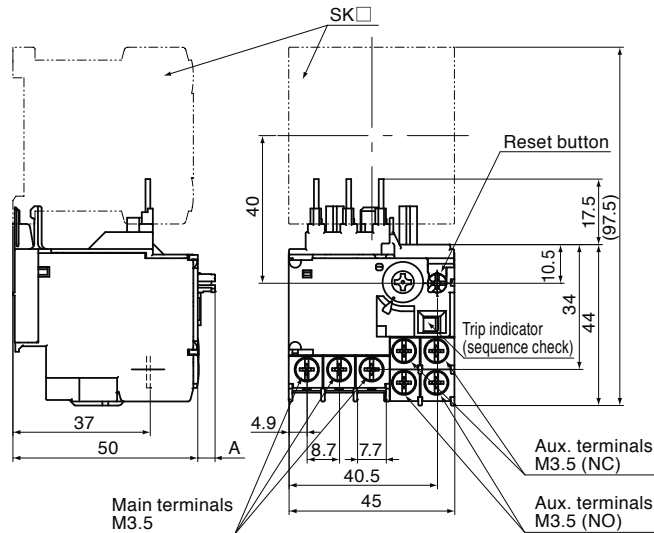

Mass : 0.1kg

Dimension A
 - Manually reset state: 5mm
 - Automatically reset state: 2mm

● Magnetic Starters (reference)

SK □ + TK12

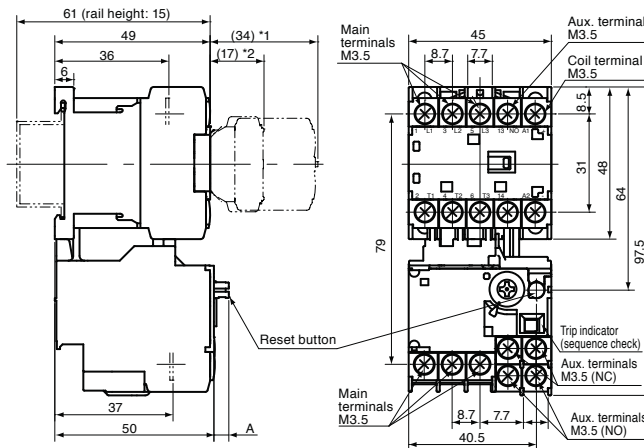

Mounting Hole Dimensions

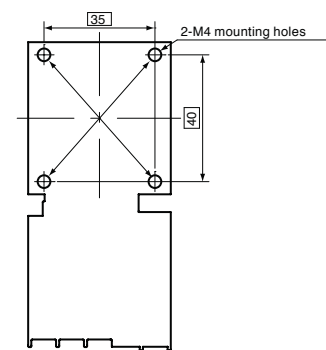

[NOTE]
 Mount the Auxiliary Overload Relay with two mounting holes in diagonally opposed corners.

Dimension A
 - Manually reset state: 5mm
 - Automatically reset state: 2mm

[NOTES]
 *1 With SZ1KA □ Auxiliary Contact Blocks.
 *2 With SZ1FA □ Auxiliary Contact Blocks.

Wiring diagram

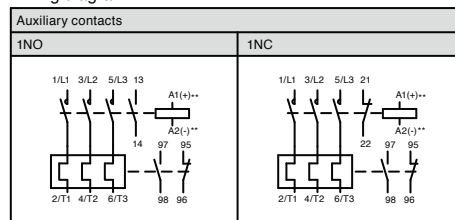

** For DC-operated models.

Mass : 0.24kg (AC-operated model)
 0.27kg (DC-operated model)

MSA CONTROL - (11) 3961-1171 - comercial@msacontrol.com.br

■ Normal Operating Conditions and Correct Mounting

● Standard Operating Conditions

Ambient temperature *1	-10 to 55°C with no sudden temperature changes resulting in condensation or icing (The average temperature over a 24-hour period must not exceed 35°C.)
Ambient humidity	45% to 85% RH (with no condensation)
Altitude	2,000 m max.
Atmosphere	No excessive dust, smoke, corrosive gasses, inflammable gases, steam, or salts
Storage temperature	-40 to 60°C
Vibration resistance	10 to 55Hz, 15m/s ²
Shock resistance	50m/s ²
Mounting	Screw mounting 35mm-wide top hat rail (Refer to the rail mounting in the next item.)

Mounting angle

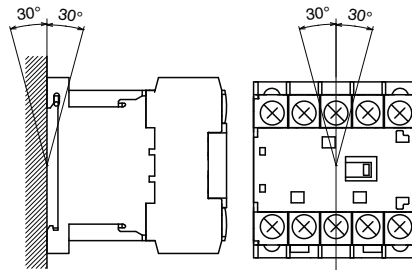

Mounting gaps *2

Provide the mounting gaps and arc space that are given in the following table when you mount the product.

A[mm]	B[mm]	C[mm]
0	10	2

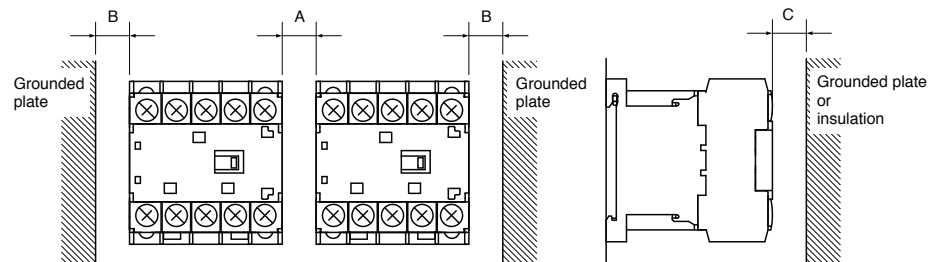

Note *1: The ambient temperature is the temperature near the product during operation.

Note *2: If Magnetic Starters are used in combination with Thermal Overload Relays and the products are used with continuous through current without providing gaps, temperature increases will reduce the life of the coil. Also, the characteristics of the Thermal Overload Relays will vary somewhat from the mutual thermal effects between the heaters. When using the products under these conditions, separate the products from each other by at least 5 mm (dimension A).

● Rail Mounting

The SK06 to SK12 Magnetic Motors and Starters can be mounted to 35mm-wide support rails. Secure the rail with the mounting pitch that is shown in the figure at the right.

Example of Applicable Rail: TH35-15AL

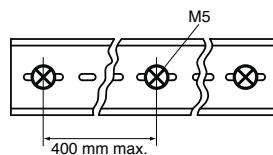

● Mounting Rail

Type	TH35-15AL
Material	Aluminum
External dimensions	

● Voltage Fluctuation Range in Control Circuits and Voltage Drop

• SK06 to SK12A (AC Operation)

Drop-out voltage (operating voltage): 85% to 110% of rated voltage
However, there is an official rated inrush voltage, but usage is possible without contact welding even if the voltage drops to 75% of the rating when the main contacts close.

• SK06 to SK12G, L-shape Drop (DC Operation)

Drop-out voltage (operating voltage): 85% to 110% of rated voltage at ambient temperature of 55°C and 80% to 110% of rated voltage at ambient temperature of 40°C.

However, there is an official rated inrush voltage, but usage is possible without contact welding even if the voltage drops to 75% of the rating when the main contacts close.

SK series and TK12 series

Notes on Use

MSA CONTROL - (11) 3961-1171 - comercial@msacontrol.com.br

■ Wiring

● Wiring and Terminal Processing



Make all connections correctly according to the connection diagram. For the SK06 to SK12, you can use solid wires, stranded wires, or crimped terminals for the main terminals, auxiliary terminals, and coil terminals.

● Tightening Torque

If the Magnetic Contactor or Switch is not mounted completely, the shock when the Contactor or Switches is turned ON may cause the contacts to jump or may reduce the durability. Also, if wires are not tightened sufficiently, they may become hot or loose, resulting in a fire, short-circuit, electric shock or some other potentially dangerous situation. Be sure to tighten the wires to the torque that is specified in the following table.

● Terminals, Wire Sizes, and Tightening Torque

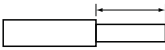
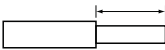
- 1) Terminals can be wired with solid wires, stranded wires, or crimped terminals can be used to connect the terminals. To use round crimped terminals, remove the terminal cover before you connect them to the terminals.
- 2) The connectable wire sizes and tightening torque are given in the following table.

		Main terminals	Control and auxiliary terminals	
Direct connection	Solid wire	[mm]	1 wire (1.2 to 2mm dia.) 2 wires (1.2 to 1.6mm dia.) 2 wires (1.6 to 2mm dia.)	
		[AWG]	1 wire x (16 to 12) 2 wires x (16 to 14) 2 wires x (14 to 12)	
	Stranded wires	[mm ²]	1 wire x (0.75 to 2.5) 2 wires x (0.75 to 1.5) 2 wires x (1.5 to 2.5)	
		[AWG]	1 wire x (18 to 14) 2 wires x (18 to 16) 2 wires x (16 to 14)	
	Sheath stripping length [mm]		10	
	Flexible stranded wires with sleeves	[mm ²]	1 wire x (0.75 to 2.5) 2 wires x (0.75 to 1.5) 2 wires x (1.5 to 2.5)	
[AWG]		1 wire x (18 to 14) 2 wires x (18 to 16) 2 wires x (16 to 14)		
Sleeve length [mm]		10		
Terminal connection	Stranded wires or flexible stranded wires	[mm ²]	0.75 to 4	0.75 to 2.5
		[AWG]	18 to 10	18 to 14
	Largest crimped terminal [mm]		7.7	
Terminal screw size		M3.5		
Tightening tool		Phillips H2 screwdriver Flat-blade screwdriver, 1x5.5xL, type B		
Flat-blade screwdriver, 1x5.5xL, type B		[N·m]	0.8 to 1.0	

Note 1. Flexible stranded wires without sleeves cannot be used. Attach sleeves before connecting the wires.

- 0.75 to 4mm² (AWG 18 to 12) stranded wire: 7 strands or less
- Flexible stranded wire: More strands than given above.

Note 2. Use DIN 46228-compliant sleeves.

- For 1.5 to 2.5mm² (AWG 16 to 14) wires, use sleeves without insulating sheaths.
- You will not be able to insert the sleeves for some crimping tools. Use a Phoenix Contact CRIMPFOX 6 crimping tool or the equivalent. Observe manufacture instructions on the wire sheath stripping lengths.

Note 3. For compliance with UL or CSA standards, you must use AWG 14 or 12 wires. Also, you must use solid wires, or use stranded or flexible stranded wires with crimped terminals or sleeves.

Note 4. Two crimped terminals can be connected.

Note 5. Do not connect anything to terminals that are not wired.

Note 6. After you bend or otherwise arrange the connected wires after wiring, make sure that the tightening torque is still correct.

Note 7. If 18 A or higher will continuously flow through a Magnetic Contactor in an environment that exceeds 40°C, wiring with 4mm² or AWG 12 wires.

MSA CONTROL - (11) 3961-1171 - comercial@msacontrol.com.br

● Handling Thermal Overload Relays

1) Adjusting the Current [Figure 1]

Turn the adjustment dial within the scale so that the total load current of the motor aligns with the triangle mark. Performance may not be dependable if the dial is set outside of the range of the scale.

2) Operation Indication [Figure 1]

When the Thermal Overload Relay operates, the white trip indicator will disappear in the operation indication window. (The white indicator will not be hidden if the Thermal Overload Relay is tripped in auto-reset status.)

3) Sequence Check [Figure 1]

You can perform a sequence check by pressing the white trip indicator in the direction of the arrow.

4) Reset Method [Figure 1]

When the Thermal Overload Relay operates, remove the cause of the error (e.g., an overload) and then press the reset button. (The Thermal Overload Relay will not reset unless it has cooled sufficiently.)

5) Auto-reset Status and Two-wire Circuits

If the Thermal Overload Relay is in auto-reset status for a 2-wire circuit and the Thermal Overload Relay resets automatically, the motor will restart operation automatically. Take adequate precautions for this.

6) Changing between Manual Resetting and Auto Resetting [Figure 2]

Use the following procedure to change between manual resetting and auto resetting. Reverse the procedure to change between auto resetting and manual resetting.

- ① Open the front cover.
- ② Use a screwdriver or similar device to press the reset button and turn it 90° clockwise.
- ③ Make sure that the reset button remains in the pressed state.
- ④ Close the front cover.

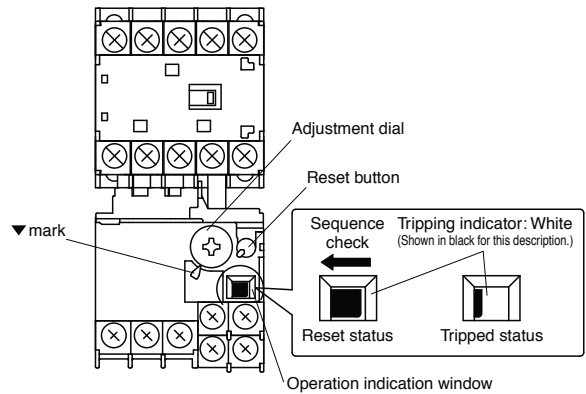

Figure 1

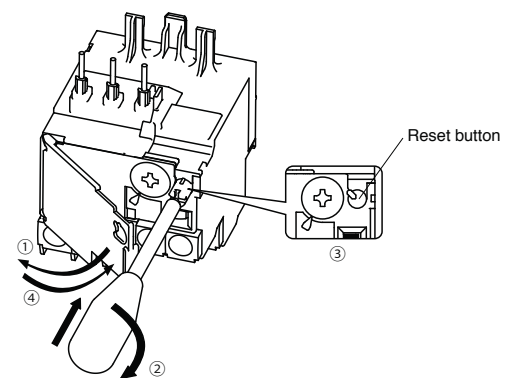

Figure 2

● Application in Single-phase Motor Circuits and DC Motor Circuits

The TK12 Thermal Overload Relays are equipped with open-phase protection. If current does not flow on all phases, the reduced operating current may cause the TK12 to operate unnecessarily. If you use the TK12 in a single-phase motor circuit or DC motor circuit, perform either (A) or (B).

(A) Connect the wiring so that series current flows to all of the poles.

(B) Set the adjustment dial to a setting that is 5% to 10% higher than normal.

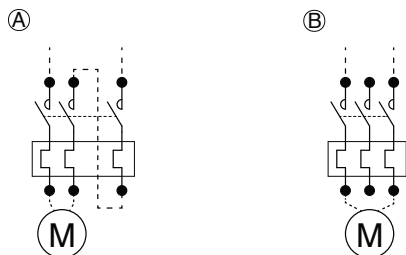

SK series and TK12 series

Notes on Use

MSA CONTROL - (11) 3961-1171 - comercial@msacontrol.com.br

● Ambient Temperature Compensation Characteristics

Changes in the ambient environment will affect the operation of the Thermal Overload Relay. The operational current will be higher at lower temperatures and lower at higher temperatures, i.e., compensation of operating characteristics will not be complete. Adjust the current according to the application environment.

The compensation coefficient for adjusting the current depends on the ambient temperature, as shown in Figure 3. If the ambient temperature in the application changes greatly, e.g., by 20°C, use the following example as a guide to calculate the adjusted current value after compensation.

Example: Calculation Method for Dial Adjustment
at an Ambient Temperature of 55°C

$$\frac{\text{Dial current at } 20^{\circ}\text{C}}{\text{Compensation coefficient at ambient temperature of } 55^{\circ}\text{C}} = \text{Dial current at ambient temperature of } 55^{\circ}\text{C}$$

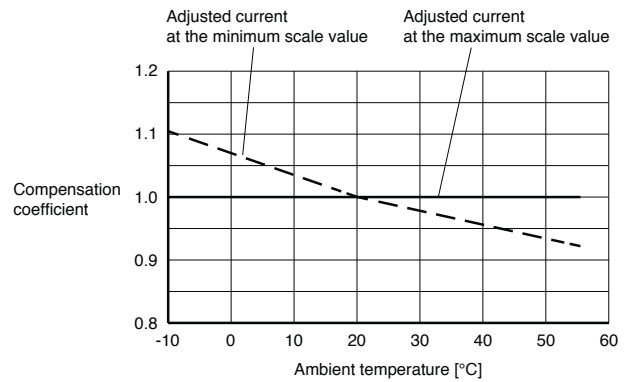

Figure 3

● Mounting the Thermal Overload Relay to and Removing It from the Magnetic Contactor

I. Mounting [Figure 4]

- 1) Loosen terminals 2, 4, and 6 on the Magnetic Contactor.
- 2) Insert the posts on the Thermal Overload Relay into the holes on the Magnetic Contactor in the direction shown by the arrows.
- 3) Insert the main circuit section of the Thermal Overload Relay on the right sides of the terminal screws.
- 4) Tighten the terminal screws on the Magnetic Contactor to the specified torque.

II. Removing [Figure 4]

- 1) Loosen the terminal screws on the Magnetic Contactor.
- 2) Move the Thermal Overload Relay left and right and pull it free from the Magnetic Contactor.

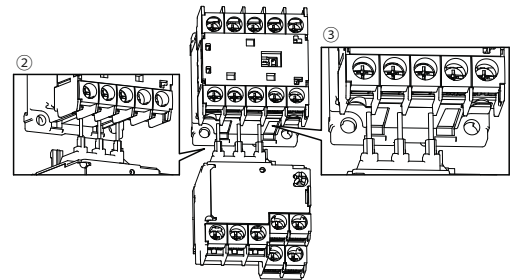

Figure 4

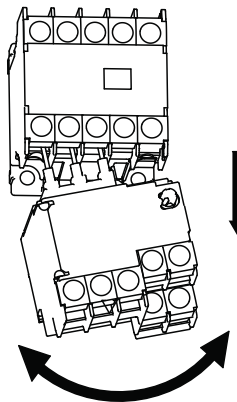

Figure 5

Combination Starters Quick Reference Guide

MSA CONTROL - (11) 3961-1171 - comercial@msacontrol.com.br

■ Features

- The user can assemble a combination starter by combining a BM3 series manual motor starter and an SC-E series or SK series magnetic contactor according to the load motor capacity.
- The manual motor starter provides overload, phase-loss, and short-circuit protections for the motor circuit, and incorporates a dial for flexible adjustment to match the total load current of the motor.
- The magnetic contactor allows remote ON/OFF operation of the motor circuit with high frequency, and features a electrical durability of one million operations.
- The manual motor starter and magnetic contactor are connected via link module and mounted to a base plate.



■ Combinations meeting for North American market

• BM3RSB, BM3RHB (General)

220-240V AC		440-480V AC		MMS part number		Contactor part number	Link module	Base plate
HP rating (HP)	Rated current (A)	HP rating (HP)	Rated current (A)	Part number	Current range (A)			
-	-	-	-	BM3RSB-P16	BM3RHB-P16	0.1-0.16 SC-E02 SC-E02/G	BZ0LRE22AA BZ0LRE22GA	BZ0BPRES22A BZ0BPRES22A
-	-	-	-	BM3RSB-P25	BM3RHB-P25	0.16-0.25 SC-E02 SC-E02/G	BZ0LRE22AA BZ0LRE22GA	BZ0BPRES22A BZ0BPRES22A
-	-	-	-	BM3RSB-P40	BM3RHB-P40	0.25-0.4 SC-E02 SC-E02/G	BZ0LRE22AA BZ0LRE22GA	BZ0BPRES22A BZ0BPRES22A
-	-	-	-	BM3RSB-P63	BM3RHB-P63	0.4-0.63 SC-E02 SC-E02/G	BZ0LRE22AA BZ0LRE22GA	BZ0BPRES22A BZ0BPRES22A
-	-	-	-	BM3RSB-001	BM3RHB-001	0.63-1 SC-E02 SC-E02/G	BZ0LRE22AA BZ0LRE22GA	BZ0BPRES22A BZ0BPRES22A
-	-	3/4	1.6	BM3RSB-1P6	BM3RHB-1P6	1-1.6 SC-E02 SC-E02/G	BZ0LRE22AA BZ0LRE22GA	BZ0BPRES22A BZ0BPRES22A
1/2	2.2	1	2.1	BM3RSB-2P5	BM3RHB-2P5	1.6-2.5 SC-E02 SC-E02/G	BZ0LRE22AA BZ0LRE22GA	BZ0BPRES22A BZ0BPRES22A
3/4	3.2	2	3.4	BM3RSB-004	BM3RHB-004	2.5-4 SC-E02 SC-E02/G	BZ0LRE22AA BZ0LRE22GA	BZ0BPRES22A BZ0BPRES22A
1-1/2	6	3	4.8	BM3RSB-6P3	BM3RHB-6P3	4-6.3 SC-E02 SC-E02/G	BZ0LRE22AA BZ0LRE22GA	BZ0BPRES22A BZ0BPRES22A
-	-	5	7.6	BM3RSB-010	BM3RHB-010	6.3-10 SC-E02 SC-E02/G	BZ0LRE22AA BZ0LRE22GA	BZ0BPRES22A BZ0BPRES22A
3	9.6	7-1/2	11	BM3RSB-013	BM3RHB-013	10-13 SC-E03 SC-E03/G	BZ0LRE22AA BZ0LRE22GA	BZ0BPRES22A BZ0BPRES22A
5	15.2	10	14	BM3RSB-016	BM3RHB-016	11-16 SC-E04 SC-E04/G	BZ0LRE22AA BZ0LRE22GA	BZ0BPRES22A BZ0BPRES22A
5	15.2	10	14	BM3RSB-020	BM3RHB-020	14-20 SC-E04 SC-E04/G	BZ0LRE22AA BZ0LRE22GA	BZ0BPRES22A BZ0BPRES22A
7-1/2	22	15	21	BM3RSB-025	BM3RHB-025	18-25 SC-E05 SC-E05/G	BZ0LRE22AA BZ0LRE22GA	BZ0BPRES22A BZ0BPRES22A
10	28	20	27	BM3RSB-032	BM3RHB-032	24-32 SC-E1 SC-E1/G	BZ0LRE32AA BZ0LRE32GA	BZ0BPRES32A BZ0BPRES32A

Combination Starters

Quick Reference Guide

MSA CONTROL - (11) 3961-1171 - comercial@msacontrol.com.br

• BM3RSB, BM3RHB (Type F coordination)

220-240V AC		440-480V AC		MMS part number			Contactor part number	Link module	Base plate	Short-circuit ratings at 480Y/277 AC (kA)	
HP rating (HP)	Rated current (A)	HP rating (HP)	Rated current (A)	Part number		Current range (A)				for BM3RSB	for BM3RHB
-	-	-	-	BM3RSB-P16	BM3RHB-P16	0.1-0.16	SC-E02 SC-E02/G	BZOLRE22AA BZOLRE22GA	BZ0BPRES22A BZ0BPRES22A	65	65
-	-	-	-	BM3RSB-P25	BM3RHB-P25	0.16-0.25	SC-E02 SC-E02/G	BZOLRE22AA BZOLRE22GA	BZ0BPRES22A BZ0BPRES22A	65	65
-	-	-	-	BM3RSB-P40	BM3RHB-P40	0.25-0.4	SC-E02 SC-E02/G	BZOLRE22AA BZOLRE22GA	BZ0BPRES22A BZ0BPRES22A	65	65
-	-	-	-	BM3RSB-P63	BM3RHB-P63	0.4-0.63	SC-E02 SC-E02/G	BZOLRE22AA BZOLRE22GA	BZ0BPRES22A BZ0BPRES22A	65	65
-	-	-	-	BM3RSB-001	BM3RHB-001	0.63-1	SC-E02 SC-E02/G	BZOLRE22AA BZOLRE22GA	BZ0BPRES22A BZ0BPRES22A	65	65
-	-	3/4	1.6	BM3RSB-1P6	BM3RHB-1P6	1-1.6	SC-E02 SC-E02/G	BZOLRE22AA BZOLRE22GA	BZ0BPRES22A BZ0BPRES22A	65	65
1/2	2.2	1	2.1	BM3RSB-2P5	BM3RHB-2P5	1.6-2.5	SC-E02 SC-E02/G	BZOLRE22AA BZOLRE22GA	BZ0BPRES22A BZ0BPRES22A	50	65
3/4	3.2	2	3.4	BM3RSB-004	BM3RHB-004	2.5-4	SC-E02 SC-E02/G	BZOLRE22AA BZOLRE22GA	BZ0BPRES22A BZ0BPRES22A	50	65
1-1/2	6	3	4.8	BM3RSB-6P3	BM3RHB-6P3	4-6.3	SC-E02 SC-E02/G	BZOLRE22AA BZOLRE22GA	BZ0BPRES22A BZ0BPRES22A	50	65
-	-	5	7.6	BM3RSB-010	BM3RHB-010	6.3-10	SC-E02 SC-E02/G	BZOLRE22AA BZOLRE22GA	BZ0BPRES22A BZ0BPRES22A	25	65
3	9.6	-	-	BM3RSB-010	BM3RHB-010	6.3-10	SC-E03 SC-E03/G	BZOLRE22AA BZOLRE22GA	BZ0BPRES22A BZ0BPRES22A	25	65
-	-	7-1/2	11	BM3RSB-013	BM3RHB-013	10-13	SC-E03 SC-E03/G	BZOLRE22AA BZOLRE22GA	BZ0BPRES22A BZ0BPRES22A	25	65
5	15.2	10	14	BM3RSB-016	BM3RHB-016	11-16	SC-E04 SC-E04/G	BZOLRE22AA BZOLRE22GA	BZ0BPRES22A BZ0BPRES22A	25	65
5	15.2	10	14	BM3RSB-020	BM3RHB-020	14-20	SC-E04 SC-E04/G	BZOLRE22AA BZOLRE22GA	BZ0BPRES22A BZ0BPRES22A	25	65
7-1/2	22	15	21	BM3RSB-025	BM3RHB-025	18-25	SC-E05 SC-E05/G	BZOLRE22AA BZOLRE22GA	BZ0BPRES22A BZ0BPRES22A	25	50
10	28	20	27	BM3RSB-032	BM3RHB-032	24-32	SC-E1 SC-E1/G	BZOLRE32AA BZOLRE32GA	BZ0BPRES32A BZ0BPRES32A	25	50

To make an application for Type F condition, You need to prepare BZ0TCRE and BZ0TKUAB accessories separately.

Combination Starters

Quick Reference Guide

MSA CONTROL - (11) 3961-1171 - comercial@msacontrol.com.br

• **BM3VSB, BM3VHB (General)**

220-240V AC		440-480V AC		MMS part number		Contactor part number	Link module	Base plate	
HP rating (HP)	Rated current (A)	HP rating (HP)	Rated current (A)	Part number	Current range (A)				
3	9.6	5	7.6	BM3VSB-010	BM3VHB-010	6.3-10	SC-E1 SC-E1/G	BZ0LVE51AA BZ0LVE51GA	BZ0BPVE51A BZ0BPVE51A
3	9.6	7-1/2	11	BM3VSB-013	BM3VHB-013	10-13	SC-E1 SC-E1/G	BZ0LVE51AA BZ0LVE51GA	BZ0BPVE51A BZ0BPVE51A
5	15.2	10	14	BM3VSB-016	BM3VHB-016	11-16	SC-E1 SC-E1/G	BZ0LVE51AA BZ0LVE51GA	BZ0BPVE51A BZ0BPVE51A
5	15.2	10	14	BM3VSB-020	BM3VHB-020	14-20	SC-E1 SC-E1/G	BZ0LVE51AA BZ0LVE51GA	BZ0BPVE51A BZ0BPVE51A
7-1/2	22	15	21	BM3VSB-025	BM3VHB-025	18-25	SC-E1 SC-E1/G	BZ0LVE51AA BZ0LVE51GA	BZ0BPVE51A BZ0BPVE51A
10	28	20	27	BM3VSB-032	BM3VHB-032	24-32	SC-E1 SC-E1/G	BZ0LVE51AA BZ0LVE51GA	BZ0BPVE51A BZ0BPVE51A
10	28	30	40	BM3VSB-040	BM3VHB-040	28-40	SC-E2 SC-E2/G	BZ0LVE51AA BZ0LVE51GA	BZ0BPVE51A BZ0BPVE51A
15	42	30	40	BM3VSB-050	BM3VHB-050	35-50	SC-E2S SC-E2S/G	BZ0LVE51AA BZ0LVE51GA	BZ0BPVE51A BZ0BPVE51A
20	54	40	52	BM3VSB-063	BM3VHB-063	45-63	SC-E3 SC-E3/G	BZ0LVE65AA BZ0LVE65GA	BZ0BPVE65A BZ0BPVE65A

• **BM3VSB, BM3VHB (Type F coordination)**

220-240V AC		440-480V AC		MMS part number		Contactor part number	Link module	Base plate	Short-circuit ratings at 480Y/277 AC (kA)		
HP rating (HP)	Rated current (A)	HP rating (HP)	Rated current (A)	Part number	Current range (A)				for BM3VSB	for BM3VHB	
3	9.6	5	7.6	BM3VSB-010	BM3VHB-010	6.3-10	SC-E1 SC-E1/G	BZ0LVE51AA BZ0LVE51GA	BZ0BPVE51A BZ0BPVE51A	25	65
3	9.6	7-1/2	11	BM3VSB-013	BM3VHB-013	10-13	SC-E1 SC-E1/G	BZ0LVE51AA BZ0LVE51GA	BZ0BPVE51A BZ0BPVE51A	25	65
5	15.2	10	14	BM3VSB-016	BM3VHB-016	11-16	SC-E1 SC-E1/G	BZ0LVE51AA BZ0LVE51GA	BZ0BPVE51A BZ0BPVE51A	25	65
5	15.2	10	14	BM3VSB-020	BM3VHB-020	14-20	SC-E1 SC-E1/G	BZ0LVE51AA BZ0LVE51GA	BZ0BPVE51A BZ0BPVE51A	25	65
7-1/2	22	15	21	BM3VSB-025	BM3VHB-025	18-25	SC-E1 SC-E1/G	BZ0LVE51AA BZ0LVE51GA	BZ0BPVE51A BZ0BPVE51A	25	65
10	28	20	27	BM3VSB-032	BM3VHB-032	24-32	SC-E1 SC-E1/G	BZ0LVE51AA BZ0LVE51GA	BZ0BPVE51A BZ0BPVE51A	25	65
10	28	30	40	BM3VSB-040	BM3VHB-040	28-40	SC-E2 SC-E2/G	BZ0LVE51AA BZ0LVE51GA	BZ0BPVE51A BZ0BPVE51A	25	65
15	42	30	40	BM3VSB-050	BM3VHB-050	35-50	SC-E2S SC-E2S/G	BZ0LVE51AA BZ0LVE51GA	BZ0BPVE51A BZ0BPVE51A	25	65
20	54	40	52	BM3VSB-063	BM3VHB-063	45-63	SC-E3 SC-E3/G	BZ0LVE65AA BZ0LVE65GA	BZ0BPVE65A BZ0BPVE65A	25	65

To make an application for Type F condition, You need to prepare BZ0TKUAB accessories separately.

Combination Starters

Quick Reference Guide

MSA CONTROL - (11) 3961-1171 - comercial@msacontrol.com.br

● Combinations with Manual Motor Starter

Magnetic Contactor type	AC480Y/277V Combined MMS		Short-circuit Current Rating (SCCR) [kA]
	Type	Ampere setting range [A]	
SK06	BM3RS□-P40	0.25-0.4	65
	BM3RS□-P63	0.4-0.63	65
	BM3RS□-001	0.63-1	65
	BM3RS□-1P6	1-1.6	65
	BM3RS□-2P5	1.6-2.5	50
	BM3RS□-004	2.5-4	50
	BM3RS□-6P3	4-6.3	50
	BM3RH□-P40	0.25-0.4	65
	BM3RH□-P63	0.4-0.63	65
	BM3RH□-001	0.63-1	65
	BM3RH□-1P6	1-1.6	65
	BM3RH□-2P5	1.6-2.5	65
	BM3RH□-004	2.5-4	65
	BM3RH□-6P3	4-6.3	65
SK09	BM3RS□-P40	0.25-0.4	65
	BM3RS□-P63	0.4-0.63	65
	BM3RS□-001	0.63-1	65
	BM3RS□-1P6	1-1.6	65
	BM3RS□-2P5	1.6-2.5	50
	BM3RS□-004	2.5-4	50
	BM3RS□-6P3	4-6.3	50
	BM3RS□-010	6.3-10	25
	BM3RH□-P40	0.25-0.4	65
	BM3RH□-P63	0.4-0.63	65
	BM3RH□-001	0.63-1	65
	BM3RH□-1P6	1-1.6	65
	BM3RH□-2P5	1.6-2.5	65
	BM3RH□-004	2.5-4	65
BM3RH□-6P3	4-6.3	65	
BM3RH□-010	6.3-10	25	
SK12	BM3RS□-P40	0.25-0.4	65
	BM3RS□-P63	0.4-0.63	65
	BM3RS□-001	0.63-1	65
	BM3RS□-1P6	1-1.6	65
	BM3RS□-2P5	1.6-2.5	50
	BM3RS□-004	2.5-4	50
	BM3RS□-6P3	4-6.3	50
	BM3RS□-010	6.3-10	25
	BM3RS□-013	9-13	25
	BM3RH□-P40	0.25-0.4	65
	BM3RH□-P63	0.4-0.63	65
	BM3RH□-001	0.63-1	65
	BM3RH□-1P6	1-1.6	65
	BM3RH□-2P5	1.6-2.5	65
BM3RH□-004	2.5-4	65	
BM3RH□-6P3	4-6.3	65	
BM3RH□-010	6.3-10	25	
BM3RH□-013	9-13	10	

MSA CONTROL - (11) 3961-1171 - comercial@msacontrol.com.br

Optional accessories

Link modules

Description	Applicable MMS	Applicable magnetic contactor	Operating coil	Type	Mass (g)
<p>The link module connects the manual motor starter and magnetic contactor electrically and mechanically.</p> <p>(No.KK01-153)</p>	BM3R	SC-E02, E03, E04, E05	AC	BZ0LRE22AA	25
		SC-E02/G, E03/G, E04/G, E05/G	DC	BZ0LRE22GA	35
		SC-E1	AC	BZ0LRE32AA	45
		SC-E1/G	DC	BZ0LRE32GA	60
	BM3V	SC-E1, E2, E2S	AC	BZ0LVE51AA	45
		SC-E1/G, E2/G, E2S/G	DC	BZ0LVE51GA	60
		SC-E3	AC	BZ0LVE65AA	65
		SC-E3/G	DC	BZ0LVE65GA	80

Base plates

Description	Applicable MMS	Applicable magnetic contactor	Operating coil	Type	Mass (g)
<p>The base plate is a plastic plate to which the combination starter is mounted. The base plate can then be mounted to a panel with screws or to a DIN rail.</p> <p>(No.KK01-155)</p>	BM3R	SC-E02, E03, E04, E05	AC	BZ0BPRE22A	100
		SC-E02/G, E03/G, E04/G, E05/G	DC	BZ0BPRE22A	100
		SC-E1	AC	BZ0BPRE32A	160
		SC-E1/G	DC	BZ0BPRE32A	160
	BM3V	SC-E1, E2, E2S	AC	BZ0BPVE51A	160
		SC-E1/G, E2/G, E2S/G	DC	BZ0BPVE51A	160
		SC-E3	AC	BZ0BPVE65A	195
		SC-E3/G	DC	BZ0BPVE65A	195

Combination starter configurations

BM3RSB+SC-E02 to E05

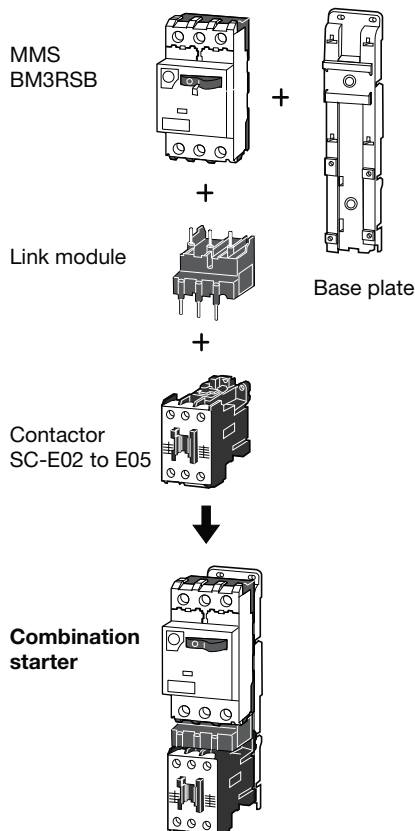

BM3RHB+SC-E04, E05

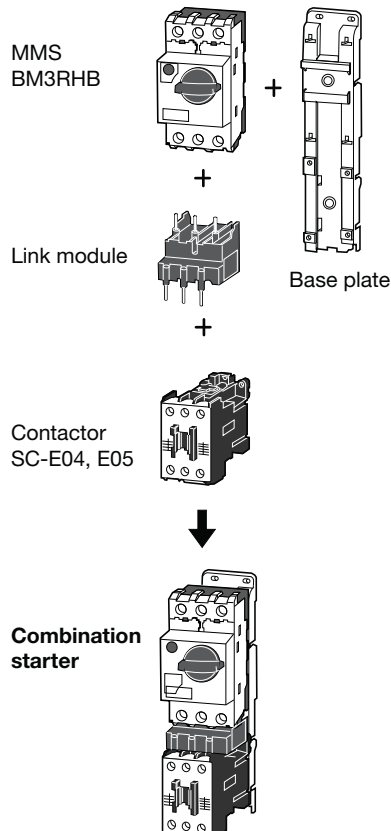

Combination Starters

Optional Accessories

MSA CONTROL - (11) 3961-1171 - comercial@msacontrol.com.br

• BM3RHB+SC-E1

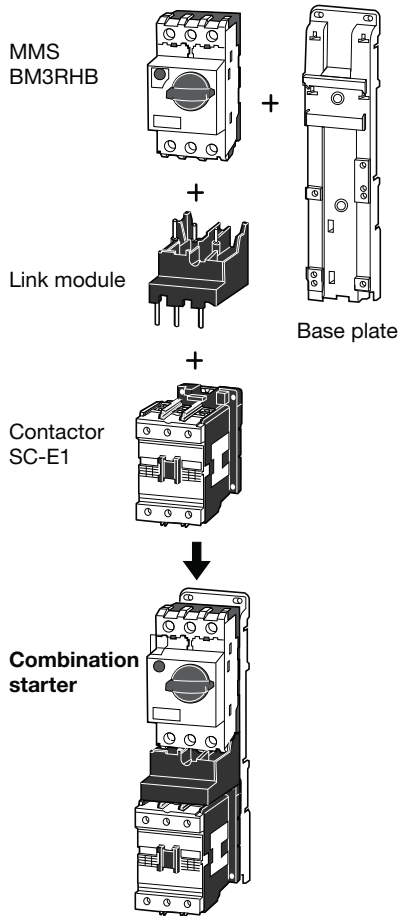

• BM3VHB+SC-E1 to E2S

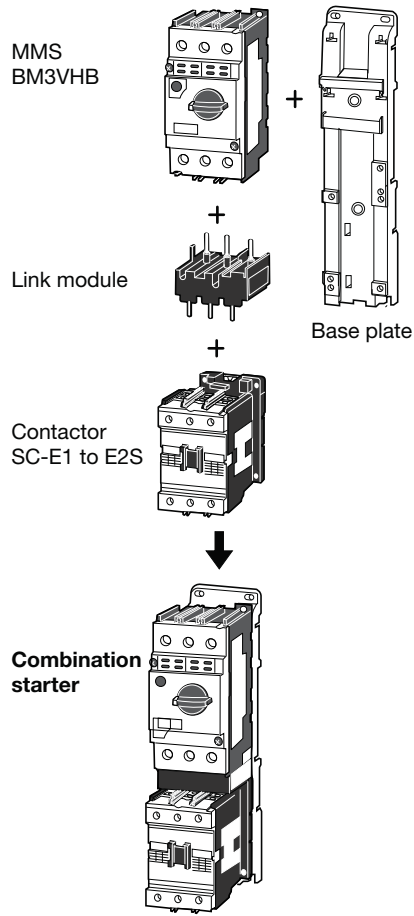

• BM3VHB+SC-E3

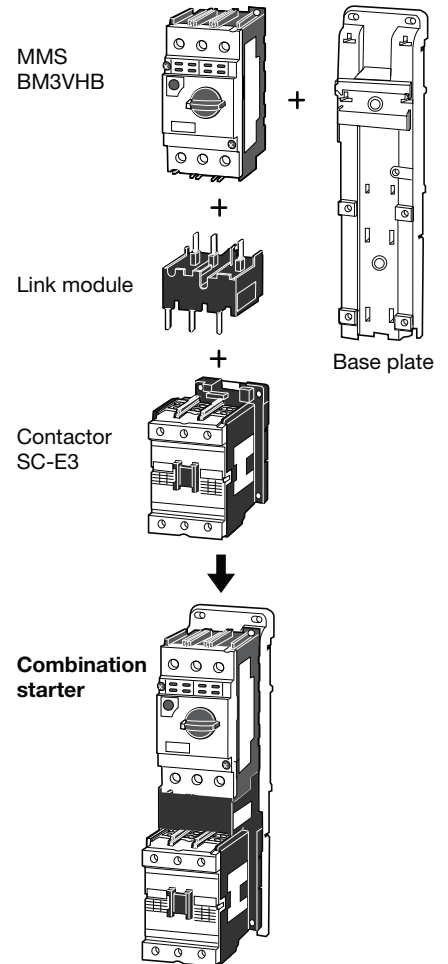

■ Notes for mounting an MMS and contactor

When the manual motor starter and magnetic contactor are configured as a combination starter, the nameplate ends up facing the wrong direction because the coil terminal of the magnetic contactor faces downward. Use the following procedure to turn the nameplate upside down.

For SC-E02 to SC-E05 magnetic contactors

- Insert a flat-blade screwdriver between the arc-chamber of the S phase or V phase and the terminal screw, and lift the arc-chamber to remove it.
- After removing the cover, turn the cover 180 degrees (top to bottom), then re-mount it onto the magnetic contactor.
- Align the cover with the top and bottom terminals and press it on firmly by hand.

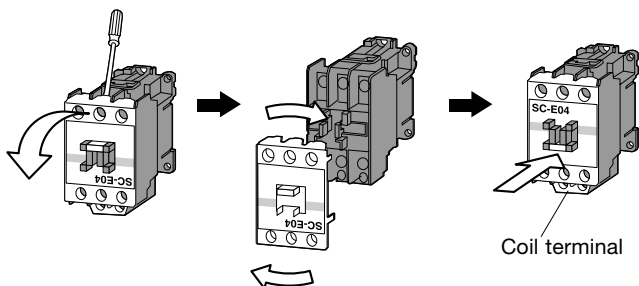

For SC-E1 to SC-E3 magnetic contactors

- Use a Phillips screwdriver to remove the two screws securing the front and back bodies.
- Remove the front body and turn it 180 degrees (top to bottom), then re-mount it with the screws.
- Make sure that no foreign matter enters the interior of the magnetic contactor during this removal and re-mounting procedure.

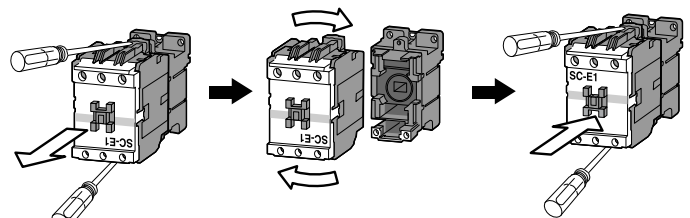

MSA CONTROL - (11) 3961-1171 - comercial@msacontrol.com.br

Link Module and Power Connection Kit for Reversing (Insert)

■ Features

- Connect a Manual Motor Starter and a Magnetic Contactor directly through a Link Module.
- A Reversing Connection Kit (Insert) for Combination Starters has joined the lineup.

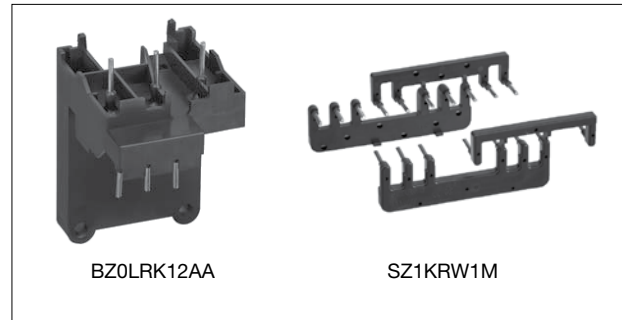

■ Types

- Link Module: Electrically and mechanically connects a Manual Motor Starter and Magnetic Contactor.

 Photo No. KKD11-101	Applicable MMS	Applicable Magnetic Contactors	Type
	BM3RSB BM3RHB	SK06, SK09, and SK12	BZ0LRK12AA

- Power Connection Kit for Reversing (Insert): Used to reverse the circuit wiring between the main circuit terminals.

 Photo No. KKD11-113	Wire size	Number of conductors per set	Applicable MMS	Applicable types	Type
	1.6 dia.	<ul style="list-style-type: none"> • One set for power supply side • One set for load side 	BM3RSB BM3RHB	SK06, SK09, and SK12	SZ1KRW1M

■ Dimensions, mm

- Link Module

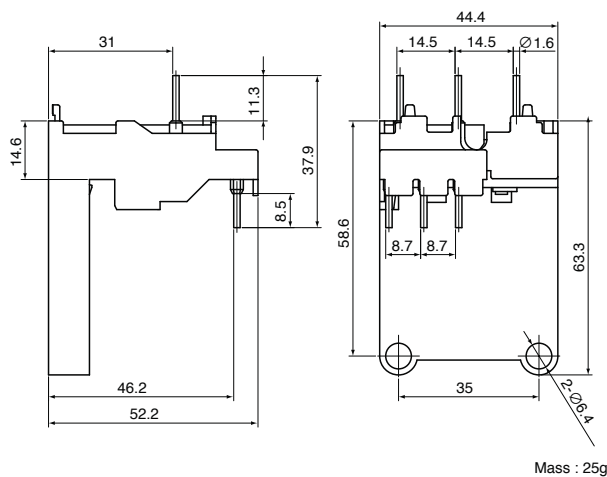

- Power Connection Kit for Reversing (Insert)

[Insert for Power Supply Side]

[Insert for Load Side]

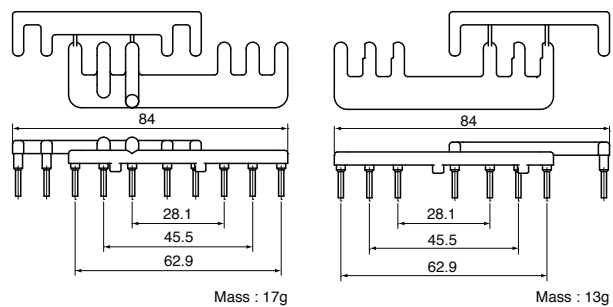

Combination Starters

Dimensions

MSA CONTROL - (11) 3961-1171 - comercial@msacontrol.com.br

■ Dimensions, mm

• Base plates BZ0BPVE22A

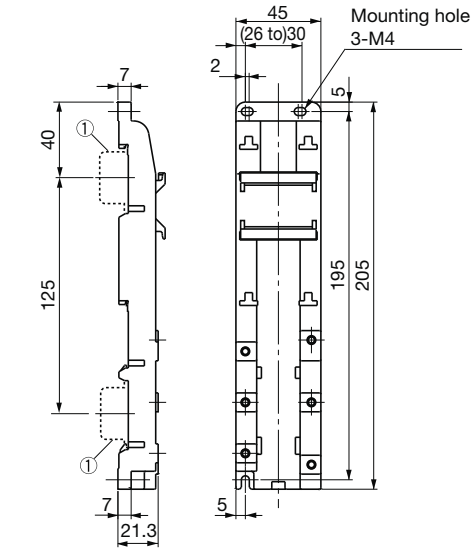

① 35mm wide rail (height 15mm) x 2

Base plate type	Applicable type	
	MMS	Contactor
BZ0BPVE22A	BM3RSB	SC-E02, E03, E04, E05
	BM3RHB	E02/G, E03/G, E04/G, E05/G

BZ0BPVE32A

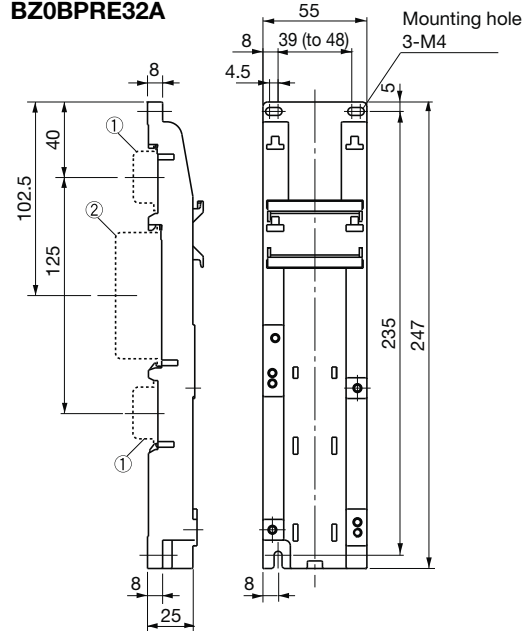

① 35mm wide rail (height 15mm) x 2
② 75mm wide rail (height 25mm) x 1

Base plate type	Applicable type	
	MMS	Contactor
BZ0BPVE32A	BM3RSB	SC-E1, E1/G
	BM3RHB	

BZ0BPVE51A

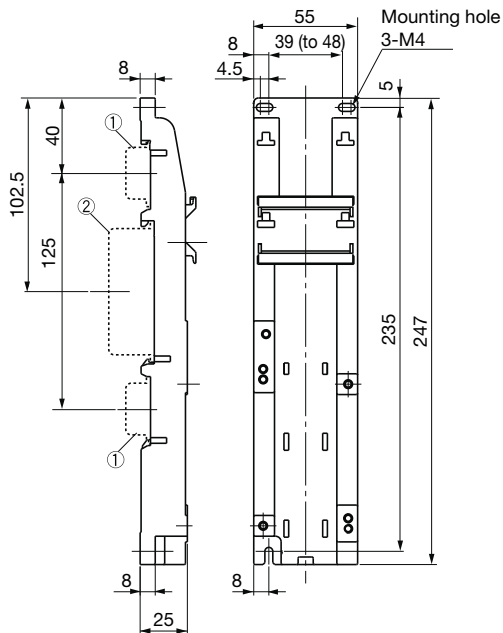

① 35mm wide rail (height 15mm) x 2
② 75mm wide rail (height 25mm) x 1

Base plate type	Applicable type	
	MMS	Contactor
BZ0BPVE51A	BM3VSB	SC-E1, E2, E2S,
	BM3VHB	E1/G, E2/G, E2S/G

BZ0BPVE65A

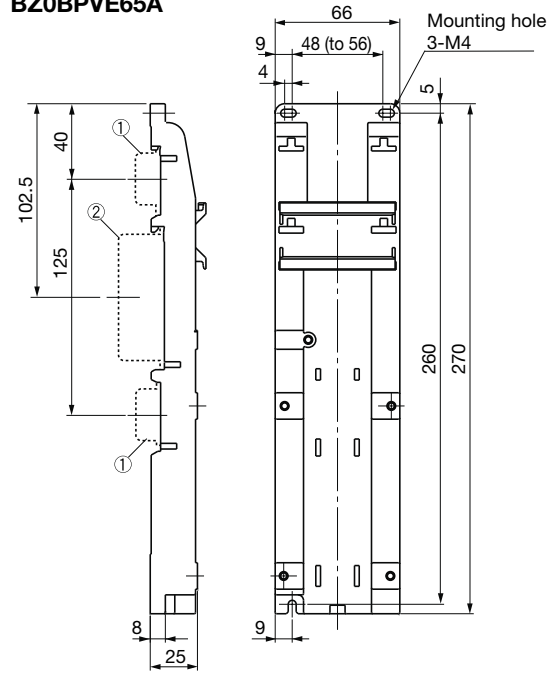

① 35mm wide rail (height 15mm) x 2
② 75mm wide rail (height 25mm) x 1

Base plate type	Applicable type	
	MMS	Contactor
BZ0BPVE65A	BM3VSB	SC-E3, E3/G
	BM3VHB	

Combination Starters Dimensions

■ Dimensions, mm MSA CONTROL - (11) 3961-1171 - comercial@msacontrol.com.br
• Combination

BM3RSB + SC-E02 to E05

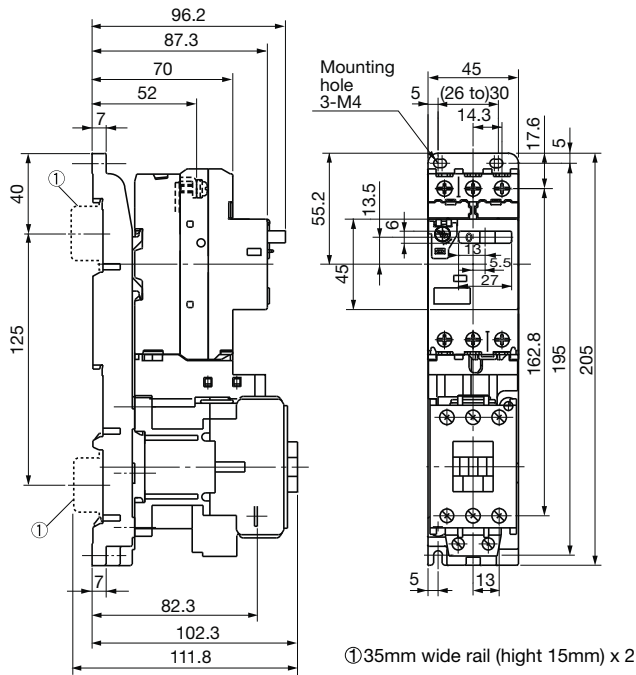

MMS	Contactors	Link module	Base plate	Mass (g)
BM3RSB	SC-E02, E03, E04, E05	BZ0LRE22AA	BZ0BPRE22A	820

BM3RSB + SC-E02/G to E05/G

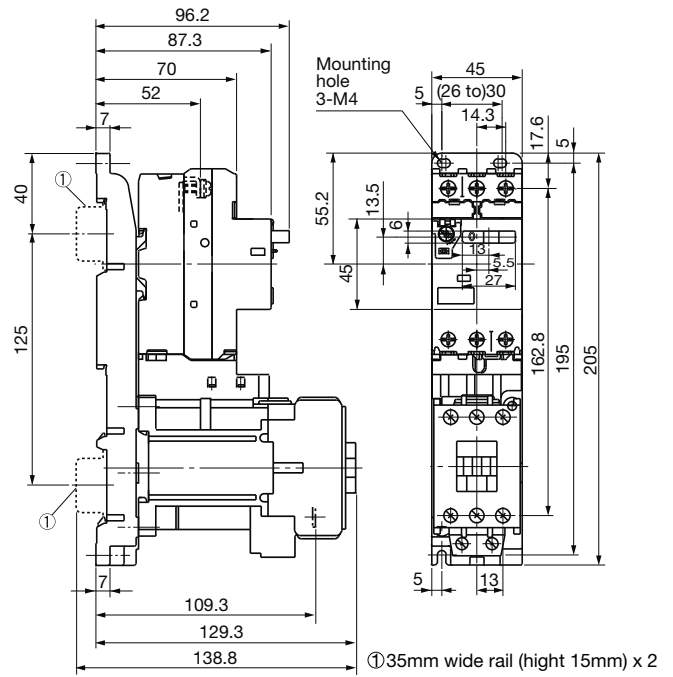

MMS	Contactors	Link module	Base plate	Mass (g)
BM3RSB	SC-E02/G, E03/G, E04/G, E05/G	BZ0LRE22GA	BZ0BPRE22A	1,065

BM3RSB + SC-E1

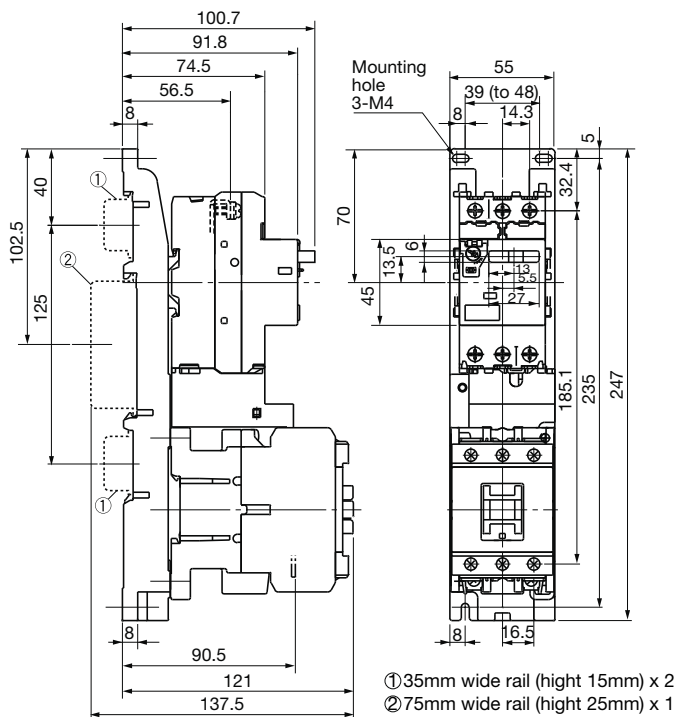

MMS	Contactors	Link module	Base plate	Mass (g)
BM3RSB	SC-E1	BZ0LRE32AA	BZ0BPRE32A	1,135

BM3RSB + SC-E1/G

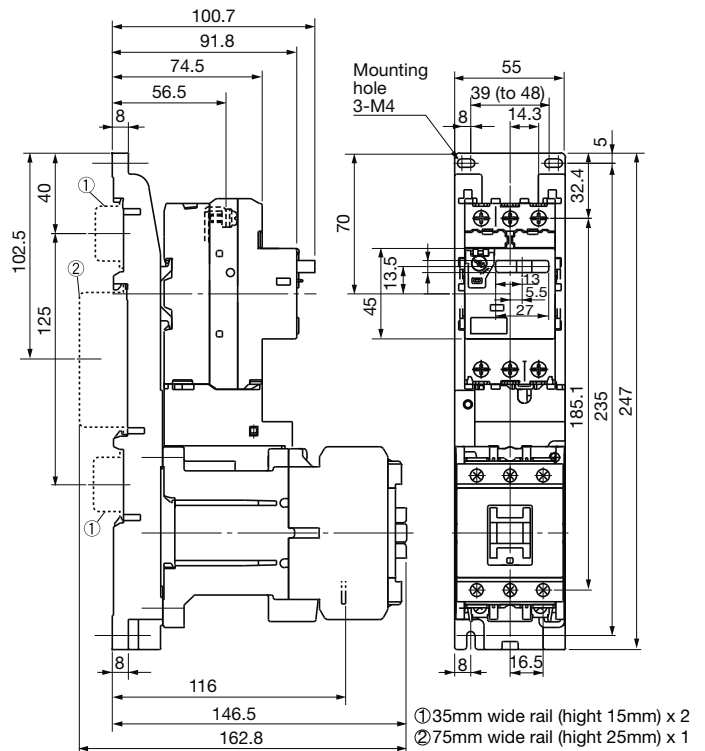

MMS	Contactors	Link module	Base plate	Mass (g)
BM3RSB	SC-E1/G	BZ0LRE32GA	BZ0BPRE32A	1,360

Combination Starters

Dimensions

■ Dimensions, mm
• Combination

MSA CONTROL - (11) 3961-1171 - comercial@msacontrol.com.br

BM3RHB + SC-E02 to E05

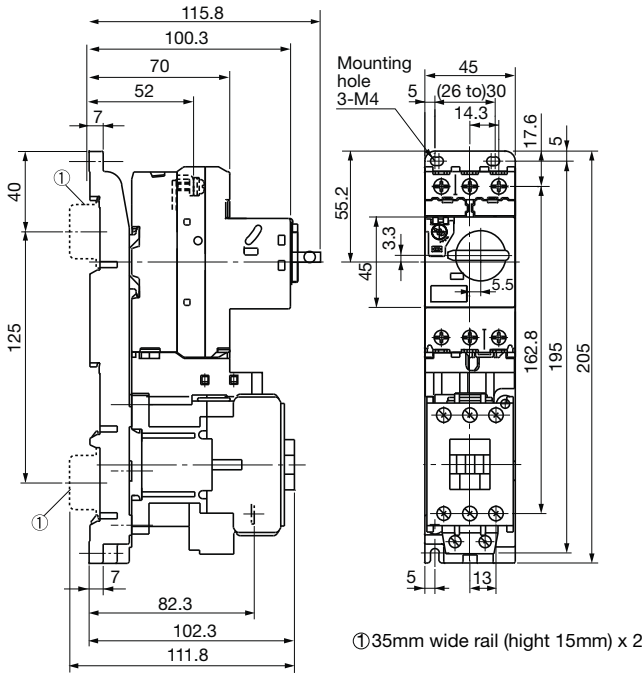

BM3RHB + SC-E02/G to E05/G

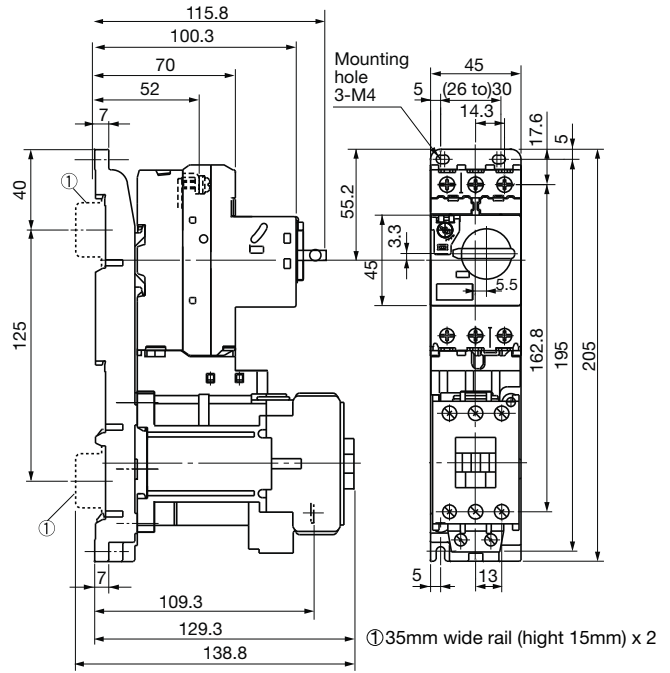

MMS	Contactors	Link module	Base plate	Mass (g)
BM3RHB	SC-E02, E03, E04, E05	BZ0LRE22AA	BZ0BPPE22A	840

MMS	Contactors	Link module	Base plate	Mass (g)
BM3RHB	SC-E02/G, E03/G, E04/G, E05/G	BZ0LRE22GA	BZ0BPPE22A	1,085

BM3RHB + SC-E1

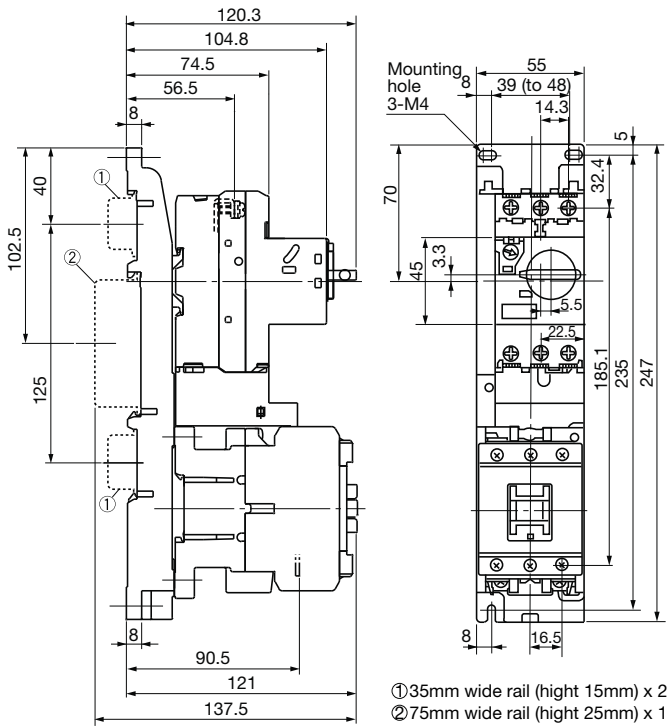

BM3RHB + SC-E1/G

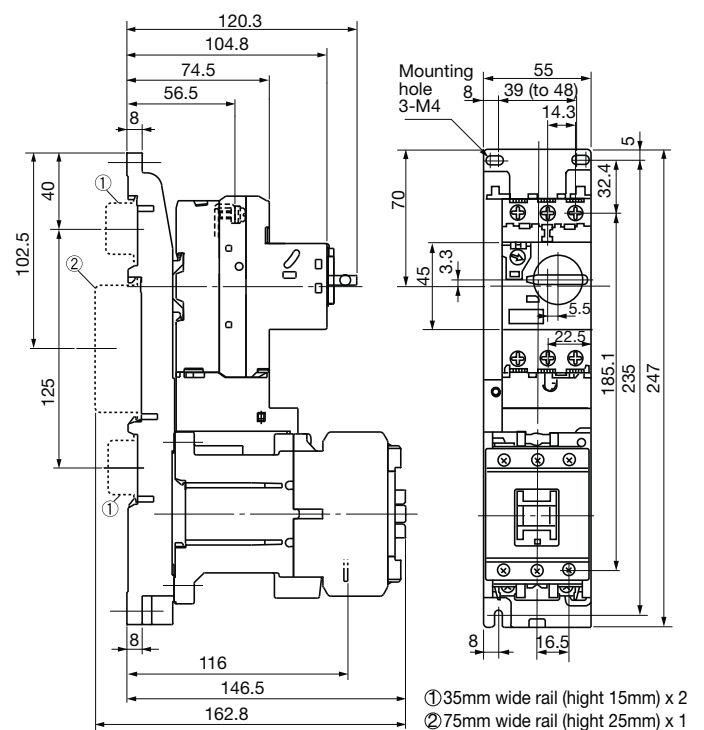

MMS	Contactors	Link module	Base plate	Mass (g)
BM3RHB	SC-E1	BZ0LRE32AA	BZ0BPPE32A	1,155

MMS	Contactors	Link module	Base plate	Mass (g)
BM3RHB	SC-E1/G	BZ0LRE32GA	BZ0BPPE32A	1,380

Combination Starters Dimensions

■ Dimensions, mm MSA CONTROL - (11) 3961-1171 - comercial@msacontrol.com.br
• Combination

BM3V□B + SC-E1, E2, E2S

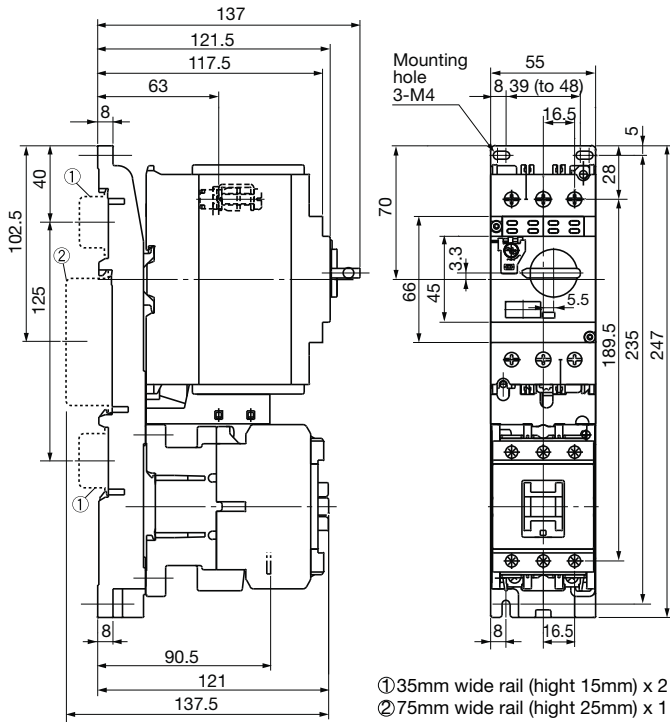

MMS	Contactors	Link module	Base plate	Mass (g)
BM3VSB	SC-E1, E2, E2S	BZ0LVE51AA	BZ0BPVE51A	1,580
BM3VHB				

BM3V□B + SC-E1/G, E2/G, E2S/G

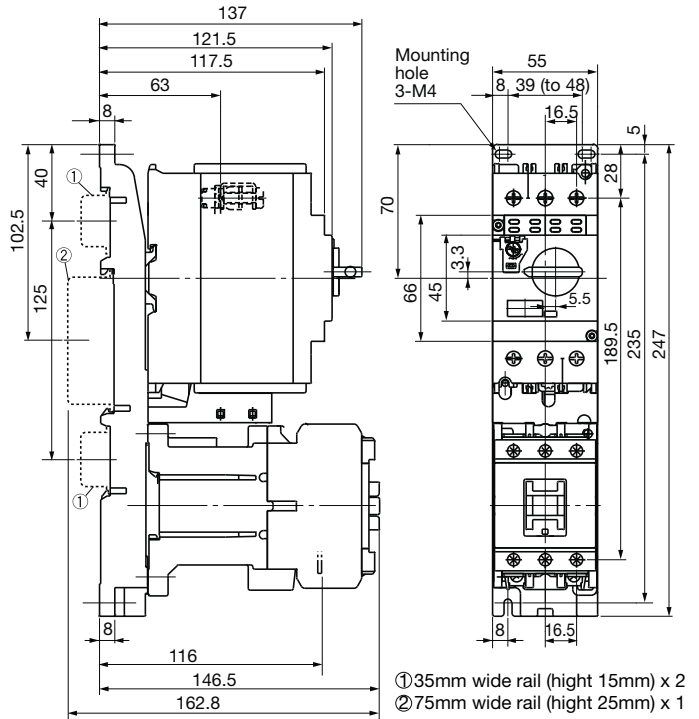

MMS	Contactors	Link module	Base plate	Mass (g)
BM3VSB	SC-E1/G, E2/G, E2S/G	BZ0LVE51GA	BZ0BPVE51A	1,810
BM3VHB				

BM3V□B + SC-E3

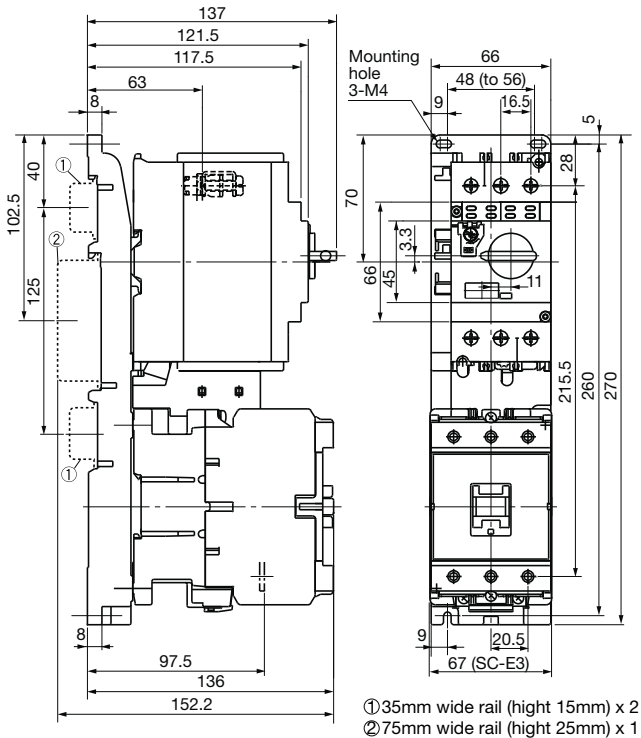

MMS	Contactors	Link module	Base plate	Mass (g)
BM3VSB	SC-E3	BZ0LVE65AA	BZ0BPVE65A	2,080
BM3VHB				

BM3V□B + SC-E3/G

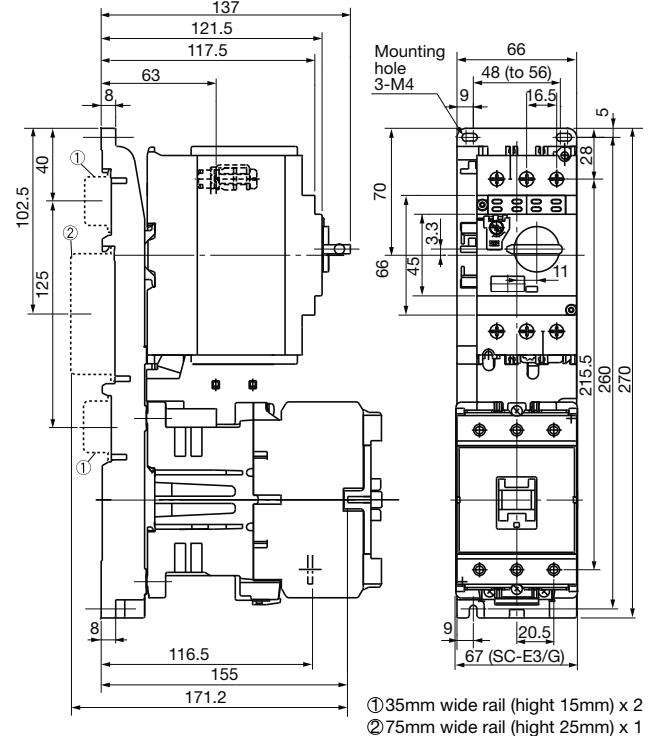

MMS	Contactors	Link module	Base plate	Mass (g)
BM3VSB	SC-E3/G	BZ0LVE65GA	BZ0BPVE65A	2,400
BM3VHB				

Combination Starters

Dimensions

MSA CONTROL - (11) 3961-1171 - comercial@msacontrol.com.br

■ Combination Starter Dimensions, mm

● BM3RS + SK□

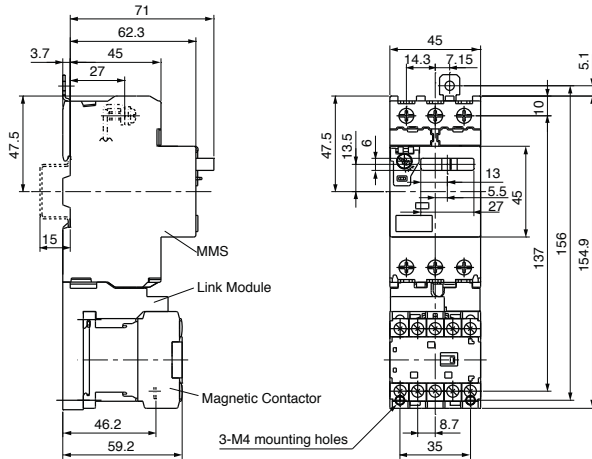

Rail mounting :
35mm rail (height: 15) x 1

MMS type	Magnetic Contactor type	Link Module type	Mass [g]
BM3RSB	SK06A, SK09A, SK12A	BZOLRK12AA	520
BM3RSR	SK06G, SK09G, SK12G SK06L, SK09L, SK12L		550

● BM3RH + SK□

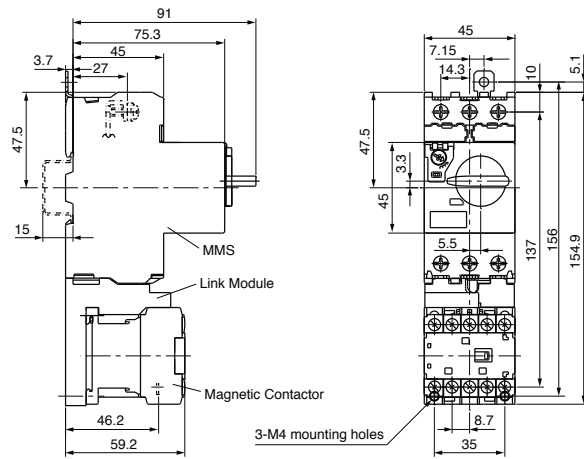

Rail mounting :
35mm rail (height: 15) x 1

MMS type	Magnetic Contactor type	Link Module type	Mass [g]
BM3RHB	SK06A, SK09A, SK12A	BZOLRK12AA	540
BM3RHR	SK06G, SK09G, SK12G SK06L, SK09L, SK12L		570

■ Reversing Combination Starter Dimensions, mm

● BM3RS + SK□R

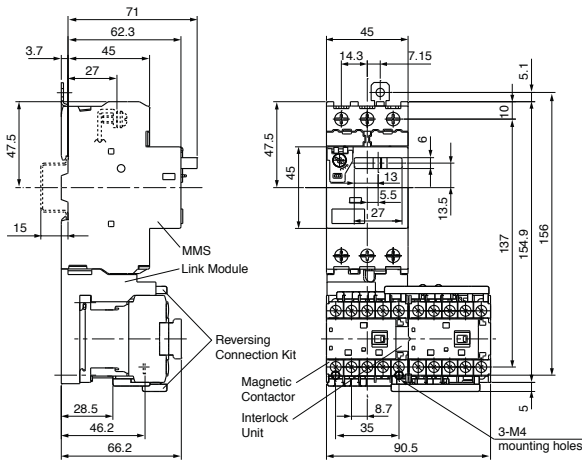

Rail Mounting :
35mm rail (height: 15) x 1

MMS type	Magnetic Starter type	Link Module type	Reversing Connection Kit	Interlock Unit	Mass [g]
BM3RSB	SK06A, SK09A, SK12A	BZOLRK12AA	SZ1KARW1M	SZ1KRM	700
BM3RSH	SK06G, SK09G, SK12G SK06L, SK09L, SK12L				760

● BM3RH + SK□R

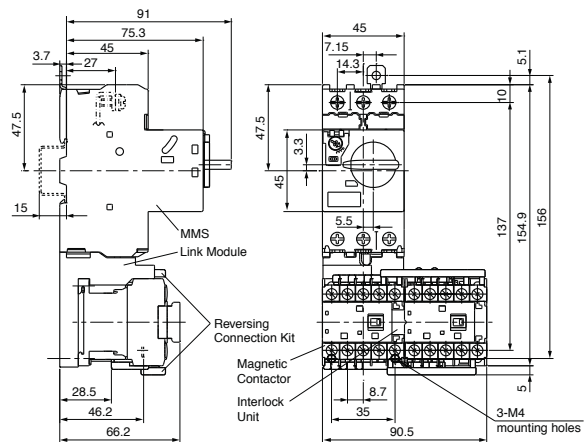

Rail mounting :
35mm rail (height: 15) x 1

MMS type	Magnetic Starter type	Link Module type	Reversing Connection Kit	Interlock Unit	Mass [g]
BM3RHB	SK06A, SK09A, SK12A	BZOLRK12AA	SZ1KARW1M	SZ1KRM	720
BM3RHR	SK06G, SK09G, SK12G SK06L, SK09L, SK12L				780

MSA CONTROL - (11) 3961-1171 - comercial@msacontrol.com.br

Appendix 1 : Construction of combination motor controllers

The UL508 standard defines 6 categories depending on the construction type for the combination motor controllers. The type and component function is shown below.

Type	Component	Component standard	Component function per NEC			
			Disconnect	Branch circuit protection	Motor control	Motor overload
A	Manual disconnect	UL98,UL1087	X			
	Fuse	UL248		X		
	Magnetic	UL508			X	
	Overload relay	UL508				X
B	Manual disconnect	UL98,UL1087	X			
	Motor short-circuit Protector	UL508		X		
	Magnetic	UL508			X	
	Overload relay	UL508				X
C	Inverse time Circuit Breaker	UL489	X	X		
	Magnetic	UL508			X	
	Overload relay	UL508				X
D	Instantaneous Circuit Breaker	UL489	X	X		
	Magnetic	UL508			X	
	Overload relay	UL508				X
E	Self-Protected control device	UL508	X	X	X	X
F	Manual Self-protected combination motor controller	UL508	X	X		X
	Magnetic	UL508			X	

Fuji Electric MMS is indicated on the label with "Manual Self-Protected Combination Motor Controller" (TYPE E) and "Combination Motor Controller" (TYPE F).

Appendix 2 : Short circuit coordination comparison

UL508 (Part IV, Combination Motor Controllers) and IEC60947-4-1 are the two major standards concerning the combination of the MMS and the Contactor. In IEC60947-4-1, it only regulates the short-circuit protective coordination between the Contactor and the Circuit Breaker. However, in UL508, it takes the combination of the MMS and Contactor as a united component and requires additional performances besides the short-circuit test.

UL standard is available for another standard related short circuit coordination, that is **UL subject 508E**

(IEC type "2" Coordination Short Circuit Tests of Electromagnetic Motor Controllers in accordance with IEC Publication 947-4-1)

UL subject 508E is to certify that the coordination between the MMS and Contactor comply with IEC60947-4-1 type 2 requirements.

Fuji Electric combination Starters are also cUL listed UL subject 508E, which means that it conforms to both UL and IEC regulation for short-circuit coordination.

Test	UL508 Type F	IEC60947-4-1		UL subject 508E
		Type 1	Type 2	
Short-Circuit Coordination	X - The contactor may be damaged - It may not be suitable for further service without repair or replacement.	X - The contactor may be damaged - It may not be suitable for further service without repair or replacement.	X - No damage except light welding of the contacts of the contactor. - It shall be suitable for further use.	X - No damage except light welding of the contacts of the contactor. - It shall be suitable for further use.
Current withstand	X	-	-	-
Dielectric voltage withstand	X	X	X	X
Calibration	X	-	X	X
Temperature	X	-	-	-
Effective region	North America	Europe	Europe	North America

Coordination details between MMS and Contactor as UL508 Type F, please see page 56, 57, as UL subject 508E, please see page 79, 80.

Appendix

MSA CONTROL - (11) 3961-1171 - comercial@msacontrol.com.br

• BM3RSB, BM3RHB (UL subject E coordination)

220-240V AC		440-480V AC		MMS part number		Contactor part number	Link module	Base plate	Short-circuit ratings at 480V AC (kA)		
HP rating (HP)	Rated current (A)	HP rating (HP)	Rated current (A)	Part number	Current range (A)				for BM3RSB	for BM3RHB	
-	-	-	-	BM3RSB-P16	BM3RHB-P16	0.1-0.16	SC-E02 SC-E02/G	BZ0LRE22AA BZ0LRE22GA	BZ0BPRE22A BZ0BPRE22A	50	50
-	-	-	-	BM3RSB-P25	BM3RHB-P25	0.16-0.25	SC-E02 SC-E02/G	BZ0LRE22AA BZ0LRE22GA	BZ0BPRE22A BZ0BPRE22A	50	50
-	-	-	-	BM3RSB-P40	BM3RHB-P40	0.25-0.4	SC-E02 SC-E02/G	BZ0LRE22AA BZ0LRE22GA	BZ0BPRE22A BZ0BPRE22A	50	50
-	-	-	-	BM3RSB-P63	BM3RHB-P63	0.4-0.63	SC-E02 SC-E02/G	BZ0LRE22AA BZ0LRE22GA	BZ0BPRE22A BZ0BPRE22A	50	50
-	-	-	-	BM3RSB-001	BM3RHB-001	0.63-1	SC-E02 SC-E02/G	BZ0LRE22AA BZ0LRE22GA	BZ0BPRE22A BZ0BPRE22A	50	50
-	-	3/4	1.6	BM3RSB-1P6	BM3RHB-1P6	1-1.6	SC-E02 SC-E02/G	BZ0LRE22AA BZ0LRE22GA	BZ0BPRE22A BZ0BPRE22A	50	50
1/2	2.2	1	2.1	BM3RSB-2P5	BM3RHB-2P5	1.6-2.5	SC-E02 SC-E02/G	BZ0LRE22AA BZ0LRE22GA	BZ0BPRE22A BZ0BPRE22A	50	50
3/4	3.2	2	3.4	BM3RSB-004	BM3RHB-004	2.5-4	SC-E02 SC-E02/G	BZ0LRE22AA BZ0LRE22GA	BZ0BPRE22A BZ0BPRE22A	50	50
1-1/2	6	3	4.8	BM3RSB-6P3	BM3RHB-6P3	4-6.3	SC-E04 SC-E04/G	BZ0LRE22AA BZ0LRE22GA	BZ0BPRE22A BZ0BPRE22A	50	50
3	9.6	5	7.6	-	BM3RHB-010	6.3-10	SC-E04 SC-E04/G	BZ0LRE22AA BZ0LRE22GA	BZ0BPRE22A BZ0BPRE22A	-	50
3	9.6	7-1/2	11	-	BM3RHB-013	10-13	SC-E05 SC-E05/G	BZ0LRE22AA BZ0LRE22GA	BZ0BPRE22A BZ0BPRE22A	-	50
5	15.2	10	14	-	BM3RHB-016	11-16	SC-E05 SC-E05/G	BZ0LRE22AA BZ0LRE22GA	BZ0BPRE22A BZ0BPRE22A	-	50
5	15.2	10	14	-	BM3RHB-020	14-20	SC-E05 SC-E05/G	BZ0LRE22AA BZ0LRE22GA	BZ0BPRE22A BZ0BPRE22A	-	50
7-1/2	22	15	21	-	BM3RHB-025	18-25	SC-E1 SC-E1/G	BZ0LRE32AA BZ0LRE32GA	BZ0BPRE32A BZ0BPRE22A	-	50
10	28	20	27	-	BM3RHB-032	24-32	SC-E1 SC-E1/G	BZ0LRE32AA BZ0LRE32GA	BZ0BPRE32A BZ0BPRE22A	-	50

MSA CONTROL - (11) 3961-1171 - comercial@msacontrol.com.br

• **BM3VSB, BM3VHB (UL subject E coordination)**

220-240V AC		440-480V AC		MMS part number			Contactor part number	Link module	Base plate	Short-circuit ratings at 480V AC (kA)	
HP rating (HP)	Rated current (A)	HP rating (HP)	Rated current (A)	Part number	Part number	Current range (A)				for BM3VSB	for BM3VHB
3	9.6	5	7.6	BM3VSB-010	BM3VHB-010	6.3-10	SC-E1 SC-E1/G	BZ0LVE51AA BZ0LVE51GA	BZ0BPVE51A BZ0BPVE51A	25	50
3	9.6	7-1/2	11	BM3VSB-013	BM3VHB-013	10-13	SC-E1 SC-E1/G	BZ0LVE51AA BZ0LVE51GA	BZ0BPVE51A BZ0BPVE51A	25	50
5	15.2	10	14	BM3VSB-016	BM3VHB-016	11-16	SC-E1 SC-E1/G	BZ0LVE51AA BZ0LVE51GA	BZ0BPVE51A BZ0BPVE51A	25	50
5	15.2	10	14	BM3VSB-020	BM3VHB-020	14-20	SC-E1 SC-E1/G	BZ0LVE51AA BZ0LVE51GA	BZ0BPVE51A BZ0BPVE51A	25	50
7-1/2	22	15	21	BM3VSB-025	BM3VHB-025	18-25	SC-E1 SC-E1/G	BZ0LVE51AA BZ0LVE51GA	BZ0BPVE51A BZ0BPVE51A	25	50
10	28	20	27	BM3VSB-032	BM3VHB-032	24-32	SC-E1 SC-E1/G	BZ0LVE51AA BZ0LVE51GA	BZ0BPVE51A BZ0BPVE51A	25	50
10	28	30	40	BM3VSB-040	BM3VHB-040	28-40	SC-E2 SC-E2/G	BZ0LVE51AA BZ0LVE51GA	BZ0BPVE51A BZ0BPVE51A	25	50

■ TERMS AND CONDITIONS OF SALE

MSA CONTROL - (11) 3961-1171 - comercial@msacontrol.com.br

Prices

All prices are subject to change without notice. In the event of a price change, the effective date of the change will be the date on the new price or discount schedule sheet.

All quotations made or orders accepted after the effective date will be based on the new prices.

Quotations

Written quotations are valid for 30 days from its date unless otherwise stated in the quotation. Verbal quotations expire the same day they are made.

Taxes

The price does not include any taxes. Buyer shall be responsible for the payment of all applicable taxes.

Terms of payment

Terms of payment will be listed on the quotations.

Minimum orders

Terms of minimum order will be shown on quotations, or if orders amounting to less than the latest minimum order amount, a handling fee will be applied.

Delivery

Delivery of products shall be FOB point of origin in the U.S. Seller shall determine the point of origin of shipment. All shipping and other charges shall be paid by Buyer.

Packing

Prices include standard domestic packing. Additional special packing costs required for export or by Buyer's request will be charged to Buyer.

Weight and Dimensions

The weight and dimensions of products described in this catalog are the best information available at the time of going to press. As Seller follows a policy of continuous product improvement, design changes may make this information obsolete. Information in this catalog is subject to change without notice.

Inspection and acceptance of products

Buyer is responsible for evaluating received products or damage for final acceptance. All claims of shortage must be made within thirty (30) days of receipt of products.

Return / Cancellation

No product shall be returned or canceled unless return/order cancel authorization has been secured from Seller. All returns/cancellations must comply with Seller's then current Return / Cancellation policy.

Risk of Loss

Risk of loss or damage to the product shall pass to Buyer at the FOB point.

Catalog Disclaimer

The information contained in this catalog does not constitute an express or implied warranty of quality, any warranty of merchantability or fitness for a particular purpose is hereby disclaimed.

Since the Buyer's product information, specific use application, and conditions of use are all outside of Seller's control, it shall be the responsibility of the Buyer to determine the suitability of any of the products mentioned for the Buyer's application.

ONE YEAR LIMITED WARRANTY

The products identified in this catalog shall be sold pursuant to the terms and conditions identified in the Conditions of Sale issued by Fuji Electric with each order confirmation. Except to the extent otherwise provided for in the Conditions of Sale issued by Fuji Electric, Fuji Electric warrants that the Fuji Electric products identified in this catalog shall be free from significant defects in materials and workmanship provided the products have not been: (1) repaired or altered by others than Fuji Electric; (2) subjected to negligence, accident, misuse, or damage by circumstances beyond Fuji Electric's control; (3) improperly operated, maintained or stored; or (4) used in other than normal use or service. This warranty shall apply only to defects appearing within one (1) year from the date of shipment by Fuji Electric, and in such case, only if such defects are reported to Fuji Electric within thirty (30) days of discovery by purchaser.

Such notice should be submitted in writing to Fuji Electric Corp. of America. The sole and exclusive remedy with respect to the above warranty whether such claim is based on warranty, contract, negligence, strict liability or any other theory, is limited to the repair or replacement of such

product or, at Fuji Electric's option, reimbursement by Fuji Electric of the purchase price paid to Fuji Electric for the particular product.

FUJI ELECTRIC DOES NOT MAKE ANY OTHER REPRESENTATIONS OR WARRANTIES, WHETHER ORAL OR IN WRITING, EXPRESSED OR IMPLIED, INCLUDING BUT NOT LIMITED TO ANY WARRANTY REGARDING MERCHANTABILITY OR FITNESS FOR A PARTICULAR PURPOSE.

Except as provided in the Conditions of Sale, no agent or representative of Fuji Electric is authorized to modify the terms of this Warranty in writing or orally.

In no event shall Fuji Electric be liable for special, indirect or consequential damages, including but not limited to, loss of use of the product, other equipment, plant, power system, loss of profits or revenues, cost of capital, or claims against the purchaser or user by its customers resulting from the use of information, recommendations and descriptions contained herein. Purchaser agrees to pass on to its customers and users, in writing at the time inquiries and orders are received by buyer, Fuji Electric's warranty as set forth above.

MSA CONTROL - (11) 3961-1171 - comercial@msacontrol.com.br

Your local authorized stocking distributor is

MSA CONTROL Indústria Elétrica Ltda.
MSA SYSTEM Elétrica Ltda.

Rua Iapó 334 - Casa Verde - São Paulo - SP - CEP:02512.02

Tel/Fax: (11) 3961.1171 - comercial@msacontrol.com.br

www.msasystemelectric.com.br & www.msacontrol.com.br

